

*schuett***biotec**.de

*Biotechnology
Microbiology
LifeScience*

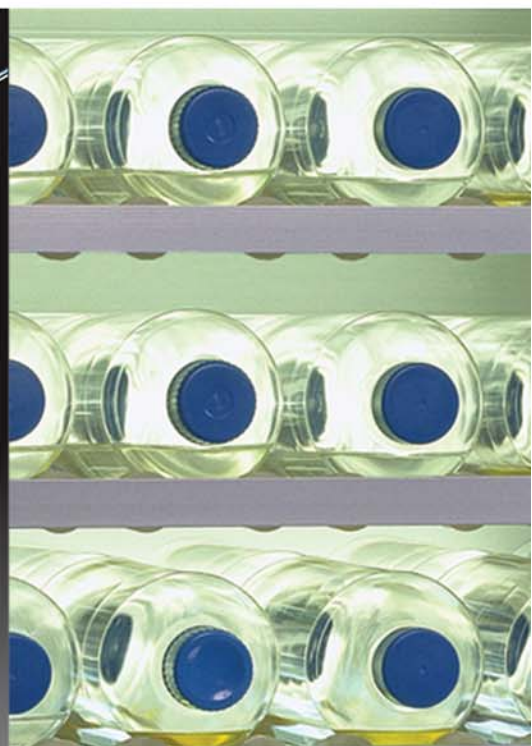

The star in your lab!

Anaerobic jars

Flexible and Robust



Anaerobic jars

For the cultivation of anaerobic and microaerophilic microorganisms in a defined and rapidly generated gas atmosphere.

Break-proof and non-aging jars made of robust stainless steel.

Transparent jars made of polycarbonate allow for optimum monitoring of colony growth during incubation process.

The lids are made of UV-resistant plastic or transparent polycarbonate, equipped with two corner valves incl. chemical-resistant tube clips for flushing and vacuum hoses (5 mm inner Ø) and with manometer for exact control of the vacuum or overpressure (-1 to +0.2 bar).

Lids as custom-made versions, e.g. made of special material or equipped for high temperatures, without valves/manometer etc. are available on request.

Optional racks for various Petri dishes, multiwell plates or test tubes available.

For comfortable operation, the Petri dish racks are equipped with special holders for GasPack-Kits.

High-quality equipment, various models – see Technical Data for more details.

Optimum atmosphere

Three methods for reaching the required gas atmosphere.

After inoculation, Petri dishes or test tubes are loaded in the corresponding optional rack and afterwards exposed to anaerobic atmosphere.

The most economic method without any chemical accessories: Evacuating the jars by using a vacuum pump and filling it with the required gas (e.g. nitrogen).

In addition, it is possible to apply the method of flushing the Anaerobic jars for 5 minutes with gas.

As an alternative, the anaerobic conditions may be reached by using chemical anaerobe systems (GasPack-Kits).

For anaerobe, microaerophilic or CO₂ atmosphere. GasPack-Kits for operation without adding water, without catalyst, no H₂-production.

Requested quantities of bags for different types of Anaerobic jars:

- "small" 1 bag
- "large" 2 bags
- "standard" 1 bag
- "crystal" 1 bag
- "eco" 1 bag

Indicator tests & Catalysts

Anaerobiosis indicator test and catalyst bags.

For use of GasPack-Kits "anaerobic" we offer corresponding indicator tests for monitoring the reached anaerobic atmosphere.

Anaerobic jar "eco" has been especially designed for operation with GasPack-Kits. The lid is equipped with a ventilation screw as well as a clip for holding the indicator test.

The indicator tests are moistened and placed in the clip for incubation together with the Petri dishes. As soon as the anaerobic conditions are reached, the indicator test decolours.

If an atmosphere providing hydrogen production is requested, we may offer corresponding safety-catalysts in bags made of stainless steel wire.

For reaching anaerobic atmosphere by help of hydrogen, we recommend threefold evacuation and filling with nitrogen. After the third filling procedure, 5 % hydrogen may be filled into the Anaerobic jar.

| | | Capacity (Liter) | Material | Fittings |
|---|---|--|--|--|
| | | Dimensions | Jar/ Lid | |
|  | <ul style="list-style-type: none"> ● Anaerobic jar "small" <p>For up to 10 Petri dishes Ø 60-100 mm</p> | 2 Liters | Stainless steel/ Plastic (black) | 2 corner valves 1 manometer |
| | | Inner Ø: Inner height: Total height: | 120 ± 1 mm 184 ± 1 mm 243 ± 1 mm | Suitable racks "small" "test tubes" |
|  | <ul style="list-style-type: none"> ● Anaerobic jar "large" <p>For up to 15 Petri dishes Ø 60-150 mm</p> | 6 Liters | Stainless steel/ Plastic (black) | 2 corner valves 1 manometer |
| | | Inner Ø: Inner height: Total height: | 175 ± 1 mm 270 ± 1 mm 330 ± 1 mm | Suitable racks "small" "standard" "150" "micro" "3x60" "test tubes" |
|  | <ul style="list-style-type: none"> ● Anaerobic jar "standard" <p>For up to 15 Petri dishes Ø 60-100 mm</p> | 3 Liters | Stainless steel/ Plastic (black) | 2 corner valves 1 manometer |
| | | Inner Ø: Inner height: Total height: | 120 ± 1 mm 280 ± 1 mm 340 ± 1 mm | Suitable racks "small" "standard" "test tubes" |
|  | <ul style="list-style-type: none"> ● Anaerobic jar "eco" <p>For up to 15 Petri dishes Ø 60-100 mm</p> | 3 Liters | Stainless steel/ Polycarbonate (PC, transparent) | Ventilation screw |
| | | Inner Ø: Inner height: Total height: | 120 ± 1 mm 280 ± 1 mm 310 ± 1 mm | Suitable racks "small" "standard" "test tubes" |
|  | <ul style="list-style-type: none"> ● Anaerobic jar "crystal" <p>For up to 15 Petri dishes Ø 60-100 mm</p> | 3 Liters | Polycarbonate (PC, transparent) | 2 corner valves 1 manometer |
| | | Inner Ø: Inner height: Total height: | 120 ± 1 mm 280 ± 1 mm 344 ± 1 mm | Suitable racks "small" "standard" "test tubes" |

All Anaerobic jars are suitable for evacuating and filling with gas as well as flushing with gas for 5 minutes and chemical gas production with GasPack-Kits (Anaerobic jar "eco" is only suitable for chemical gas production).

Data and Facts



Anaerobic jar "standard" with Petri dish rack "standard"



Anaerobic jar "crystal" with Petri dish rack "standard", loaded with GasPack and catalyst (optional)

Ordering information

| | Cat.-No. |
|--|------------------|
| Anaerobic jar "small" for up to 10 Petri dishes Ø 60-100 mm | 3.380 202 |
| Anaerobic jar "large" for up to 15 Petri dishes Ø 60-150 mm | 3.380 102 |
| Anaerobic jar "standard" for up to 15 Petri dishes Ø 60-100 mm | 3.380 302 |
| Anaerobic jar "eco" for up to 15 Petri dishes Ø 60-100 mm | 3.380 502 |
| Anaerobic jar "crystal" for up to 15 Petri dishes Ø 60-100 mm | 3.380 902 |

Accessories

| | |
|--|------------------|
| Petri dish rack "small" or up to 10 Petri dishes Ø 60-100 mm | 3.385 102 |
| Petri dish rack "standard" for up to 15 Petri dishes Ø 60-100 mm | 3.385 202 |
| Petri dish rack "150" for up to 15 Petri dishes Ø 60-150 mm | 3.385 302 |
| Petri dish rack "3x60" for up to 45 Petri dishes Ø 60 mm | 3.385 402 |
| Petri dish rack "micro" for multiwell plates | 3.385 502 |
| Test tube rack "test tubes" for 9 test tubes up to Ø 18 mm | 3.385 602 |

| | |
|---|------------------|
| GasPack-Kit "anaerobic" for oxygen free atmosphere in approx. 30 min, with < 1 % O ₂ and 9-13 % CO ₂ , Active reagent: ascorbic acid 1 bag = 3.5 l capacity (qty=10 bags) | 3.880 300 |
| GasPack-Kit "CO₂" for CO ₂ atmosphere in 60-90 min, with approx. 15 % O ₂ and approx. 10 % CO ₂ 1 bag = 3.5 l capacity (qty=10 bags) | 3.880 400 |
| GasPack-Kit "microaerophil" for microaerophilic atmosphere 1 bag = 3.5 l capacity (qty=10 bags) | 3.880 500 |
| Anaerobiosis indicator test (qty=100 strips) | 3.880 600 |
| Safety Catalyst Set (qty=5 bags) | 3.880 700 |

schuett **biotec**.de

Rudolf-Wissell-Straße 13, D-37079 Göttingen, Germany
Fon +49 (0) 551/5 04 10-0, Fax +49 (0) 551/5 04 10-99
info@schuett-biotec.de
www.schuett-biotec.de

schuett phoenix II

The new sense of flaming



schuett **biotec**.de

Safety Bunsen Burner

For flame-sterilizing,
scarfing or heating



schuett phoenix II
Unique Bunsen Burner with highest safety standard and outstanding quality features.

For operation in microbiological safety cabinets or in the chemical laboratory.

Designed for laboratory requirements in research, industry and education.

- *Operating information in written form for most international languages*
- *Easy-to-read highlighted colour display*
- *Unique joystick navigation*
- *Comfortable operation by hand, foot-switch or motion sensor mode*
- *3 models available*



schuett phoenix II standard

- Colour display and language selection, sensor and foot-switch.
- Flame activation by sensor 1x or 2x, foot-switch or pressing button by hand (START/STOP).
- Display of burn-time (1 sec...120 min) digitally visualized and adjustable to the second in all operating modes.

schuett phoenix II eco

- Best suited for safety cabinets.
- Flame activation by foot-switch or pressing button by hand (START/STOP).
- Best low-cost-model.

schuett phoenix II accu

- Colour display and language selection, sensor and foot-switch (optional), built-in high-power battery.
- Ideal for mobile operation.
- Flame activation by sensor 1x or 2x, foot-switch or pressing button by hand (START/STOP).
- Display of burn-time (1 sec...120 min) digitally visualized and adjustable to the second in all operating modes and with display of battery power status.
- Battery operating time:
30 hours in cyclic operation (ON_4 sec...OFF_12 sec)
15 hours in continuous operation (ON).
- Complete with high-speed battery charger incl. overcharge protection, the burner may also be operated during charging process. After 3 hours of charging, the schuett phoenix II accu is ready for mobile operation again.



User navigation - comfortable and comprehensible



Large display - multilingual menu navigation - easy self-explanatory operation

Excellent readability, highlighted LED-Display, even with bright ambient light, offers maximum comfort and easy menu navigation, comprehensible in standard international languages.

Clever design facilitates work

The gas and air control as well as the joystick for menu navigation are clearly arranged and easily accessible at the burner's front.

Service

The burner head may be easily removed for cleaning or replacement by the user without need for tools.

Easy to clean

The surface of the stainless steel housing is specially treated and dirt-repellent. The display is made of tempered special glass. Display and housing may be easily cleaned and kept sterile by flame-sterilization. No discoloring thanks to UV-resistant housing.

Self-explanatory menu navigation in most international languages.

Gas and air adjustment with "Click-Stop"-feature

ON- and OFF-switch as well as comfortable joystick for menu navigation



Highest comfort.
Clever design facilitates work.

Modern Design**

The schuett phoenix II with its new design - easy to handle, robust and operated without the slightest effort.

Large Display

A well readable, highlighted colour LED-display offers maximum comfort.

Self-explanatory operation

Easy and comprehensible menu navigation.
Choose your language and have all settings, information and warning remarks of the schuett phoenix II shown in more than 10 international languages.

Reliable and safe.
State-of-the-art technology.

Information and warning remarks

Have all information and warning remarks of the schuett phoenix II Safety Bunsen Burner shown in your language.

Stable flame

Even in strong currents inside a safety cabinet.

No soiling

An outlet inside the burner drains liquids. A special filter prevents particles from entering the burner.

Overheating protection with sensors

Double temperature control:
The burner itself does not heat up to more than 60 °C even in continuous mode. A clearly visible and blinking remark in the display warns the user to beware of the hot burner head.

Safety shutdown

Highest safety by automated shutdown if the burner is not operated (after 15, 30, 60 or 120 min, adjustable).

** design patent

No more trouble with the flame

The benefits are in the details - extensive range of accessories, for any application.

Tilting



schuett phoenix II may be tilted to both sides with a bracket underneath the burner (suitable for left and right hander). This facilitates flame-sterilizing of e.g. bottle-necks. The risk of spilling liquids into the burner is minimized.

Instrument tray



The instrument tray allows for putting down inoculating loops and tweezers for cooling. The tray may be mounted to the right or to the left side of the burner and can be moved by the user for optimum workplace convenience.

Foot-switch



The foot-switch made of premium stainless steel is suitable for all 3 models. Round, easy and safe all-over access by foot.
Slip-proof and stable.

Universal power supply

The universal power supply (100-240 V) includes a set of exchange plugs in the delivery extent to guarantee immediate readiness for operation of the schuett phoenix II - worldwide.

Burner head

The burner head is easily removable for cleaning without need for tools. It has been designed to allow for cleaning in a dish washer.

Choose your preferred operating mode:

- **Activation by IR-sensor**
- **Activation by hand/button**
- **Activation by foot-switch**

Activation by IR-sensor - sensor feature adjustable by the user

Precise flame activation.
The burner may be started and stopped by a movement of the hand or a pipette/inoculating loop in front of the IR-Sensor (1x operation, 2x operation).
This new feature as well as the sensor indicator lamps in the display, provide the user with maximum safety. The sensor sensitivity may be freely adjusted within 4 levels. Upon ignition the gas supply is automatically cut after the exact preset time (1 sec... 120 min) has elapsed and the flame stops.

Activation by hand/button

The flame may be started and stopped by simply pressing the button by hand or it stops after the preset time has elapsed.

Activation by foot-switch, mode 1

The flame is only burning as long as the foot-switch is pressed and is thereby permanently controlled. As soon as the foot is removed from the foot-switch, the gas supply is cut and the flame stops.

Activation by foot-switch, mode 2

The flame is activated as soon as the foot-switch is shortly pressed and stops after shortly pressing again or after the preset time has elapsed.

The remaining burn-time is permanently shown in the display.

Certified safety

The schuett phoenix II meets the latest safety regulations such as DIN 30665 part 1 and has been registered under DIN-DVGW-certificate NG-2211AR0750.

Perfect start at any time

The schuett phoenix II guarantees highest safety standards

Controlled burn-time:

Digitally visualized and exact to the second adjustable burn-time (1 sec... 120 min).

Automated safety shutdown of the burner.

Exact flame adjustment:

Economic operation, easy handling provided by state-of-the-art regulation system. Choose yourself - soft, bright or sharp flame. The exact setting of burn-time and the precise flame adjustment by using the "Click-Stop"-feature, both considerably reduce the gas consumption.

Flame monitoring:

No interruption of your work.

In case of inadvertently extinguishing the flame, it is automatically re-ignited.

Ignition monitoring:

The display shows the remark "Check gas supply".

If no flame may be produced after 10 seconds of automated re-ignition, the schuett phoenix II automatically cuts the gas supply permanently.

Permanent burner control:

The display shows the remark "Clean burner head".

If the flame stops due to e.g. spilled liquids and the burner may not be re-ignited, the gas supply is automatically and permanently shut.



Gas-safety hose for natural gas, slip-on (DVGW-certified)



Gas-safety hose for propane/butane, screwed (DVGW-certified)

Sources of energy? You need it - we have it



schuett phoenix II with CV 360-adapter incl. pressure reducer and cartridge



schuett phoenix II with C 206-adapter incl. pressure reducer and gas-safety hose as well as cartridge

Optional to operate with central gas supply (natural gas) or with gas cartridges (propane/butane)

The delivery extent of the schuett phoenix II includes a nozzle for natural gas as well as a nozzle for propane/butane gas. In few steps, the nozzles may be exchanged or replaced, without need for tools, according to the required gas.

The schuett phoenix II is suitable for operation with various gas cartridges (with or without integrated valve, propane/butane or butane). The corresponding gas cartridge adapters are equipped with pressure reducer and gas-safety hose or are designed for direct mounting to the burner.

Even gas bottles (e.g. in sizes of 5 or 11 kg) may be connected to the schuett phoenix II by using a gas-safety hose and a separate pressure reducer.

The gas connection of the schuett phoenix II is both suitable for slipping-on natural gas hoses as well as screwing threaded propane/butane gas hoses.

Adapters for the following gas cartridges are available as standards. They are equipped with a pressure reducer and DVGW*-certified gas-safety hose or designed for direct mounting to the burner. **



CV 360

- Cartridge with valve
52 g butane gas
Ø burn-time (continuous): approx. 40 min*



C 206 (worldwide available)

- Pierceable cartridge without valve
190 g propane/butane gas (80/20)
Ø burn-time (continuous): approx. 160 min*



CV 270 / CV 300 / CV 470

- Cartridges with valve
230 g / 240 g / 450 g propane/butane gas (80/20)
Ø burn-time (continuous): approx. 180 min / 190 min / 350 min*



Express 444

- Cartridge with valve,
60 g propane/butane gas
Ø burn-time (continuous): approx. 50 min*



CG 1750 / AT 2000

- Cartridge with valve
175 g propane/butane gas (70/30)
Ø burn-time (continuous): approx. 150 min*



CP 250

- Cartridge with valve
250 g butane gas
Ø burn-time (continuous): approx. 210 min*



R 901 / R 904 / R 907

- Refillable gas bottles without valve (purchasable bottles for international Campingaz®-exchange system)
400 g / 1.8 kg / 2.75 kg butane gas



**Adapters for other cartridges available on request.

* approximate values, depending on gas adjustment, ambient temperature etc.

Mobile flame sterilizer

schuett easyflame

Flame sterilizer

- mobile and handy
- operation with gas cartridges or natural gas
- piezo-ignition

For sterilizing fire-proof working surfaces and devices, e.g. in production, research and quality control. Piezo-electric ignition at the push of a button. Infinite adjustment of the flame. Gas supply control for producing a "soft" or "sharp" flame.



2 models available:

schuett easyflame to use with propane/butane gas, suitable for all gas cartridges with 7/16" connection thread, e.g. CG 1750. Adapter for CV 360 cartridges optionally available.

schuett easyflame^{plus} to use with natural gas, use of the central gas supply in the lab.

Light-weighted and handy, ready-to-use in every situation, even overhead. Single-handed operation. In short-term use, the flame is activated as long as the push button is pressed. For continuous operation with lock key.

For flame sterilizing cotton or butyl rubber plugs with a "soft/coloured" flame at low temperature. For safe and gentle sterilization.

For sterilizing bottlenecks, hose connections and openings, e.g. when loading autoclave or fermenter. Keeps the air at the opening sterile.

For sterilizing of fire-proof surfaces of product packing in Quality Control before taking out the sample.

Flame sterilization carousels

Flame sterilization carousels

- Rotation und scarfing happen semi- or fully automated
- No need for cooling down of inoculating loops in agar
- Sterilizing time adjustable

Semi-automated:

schuett easyloop (for 6 inoculating loop holders)

The rotation is effected manually, while the flaming process is fully automated. Operated in combination with Safety Bunsen Burners schuett phoenix II standard and accu.



Fully automated:

schuett flammy R (for 5 inoculating loop holders)

Ideal for flame sterilization of inoculating loops in combination with gas-safety-burners.

Your benefit from both models

The flame sterilizing time is infinitely adjustable
1 s to 120 min (easyloop)
2 to 10 s (flammy R)

Accurate flame sterilizing adjustment according to type of inoculating loop. Minimizes the gas consumption and increases the longevity of the inoculating loops.

The inoculating loop holder with the inoculating loop is placed into the carousel after use and will be rotated manually by hand or automatically moved to the burner where it is flame sterilized.

The carousels have been designed for continuous work-flow with sample series, e.g. for the work-bench.

Inoculating loops - Holders - Racks

Inoculating loops, sterilizable

Made of three different materials. Suitable for multiple flame sterilization. Best results in long-term tests.

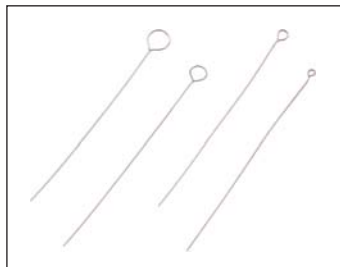

Stainless steel

0.5 mm thickness, 60 mm long (qty=10)

| | |
|----------------------|-----------|
| Loop diameter 1.5 mm | 3.686 312 |
| Loop diameter 2.5 mm | 3.686 322 |
| Loop diameter 4 mm | 3.686 332 |

Special stainless steel

0.5 mm thickness, 60 mm long (qty=10)

| | |
|--------------------|-----------|
| Loop diameter 1 mm | 3.686 112 |
| Loop diameter 2 mm | 3.686 122 |
| Loop diameter 3 mm | 3.686 132 |
| Loop diameter 5 mm | 3.686 152 |

Platin-Iridium-wire (90/10),

0.5 mm thickness, 60 mm long (qty=1)

| | |
|--------------------|-----------|
| Loop diameter 1 mm | 3.686 212 |
| Loop diameter 2 mm | 3.686 222 |
| Loop diameter 3 mm | 3.686 232 |
| Loop diameter 5 mm | 3.686 252 |

Wire made of Platin-Iridium (90/10)

| | |
|------------------|-----------|
| 0.5 mm thickness | 3.686 050 |
|------------------|-----------|

Inoculating loop holders

Made of stainless steel with handle. For inoculating loops with wire thickness 0.5 to 0.7 mm. Fixture with lock nut.



Inoculating loop holders

| | |
|---------------------------------|-----------|
| Inoculating loop holders 160 mm | 3.686 362 |
| Inoculating loop holders 240 mm | 3.686 442 |

Racks for inoculating loop holders made of PVC

with 6 holes a Ø 7 mm.



| | |
|------------------------------|-----------|
| Rack R (round) | |
| 80 x 50 mm (Ø x h) | 3.687 082 |
| Rack L (long) | |
| 180 x 50 x 50 mm (w x h x d) | 3.687 182 |

Data and facts



schuett phoenix II with glass spatter guard



schuett phoenix II with flame shield



Hot-Tray with schuett phoenix II and CV 360-adaptor/cartridge for operation in chemical lab (height-optimized)



Instrument tray with inoculating loop holder, rotatable for optimum workplace convenience



Choice of gas cartridges with adapters, partially including pressure reducer and gas-safety hose.

schuett phoenix II Safety Bunsen Burner

| | |
|---|--------------------------------|
| Burn-time, adjustable (standard/accu) | 1 sec - 120 min |
| Line/mains voltage power supply | 100-240 V AC, +/- 5%, 50-60 Hz |
| Connected voltage (standard/accu) | 6 V DC, 3 VA max. |
| Maximum burn-time with battery, continuous ON (accu) | 15 hours |
| Olive-shaped hose coupling for gas hose (natural gas) | 10 mm diam. (inner) |
| Working pressure natural gas / propane/butane gas | 20 mbar / 50 mbar |
| Rated heat load natural gas / propane/butane gas | 600 W / 1200 W |
| Consumption natural gas / propane/butane gas | 0.06 cbm/h / 77.2 g/h |
| Dimensions (w x h x d) | 125 x 85 x 160 mm |
| Weight | approx. 1000 g |

Ordering information

| | |
|---|-----------------------|
| schuett phoenix II eco with foot-switch | Cat.-No. 3.354 202 |
| schuett phoenix II standard with sensor and foot-switch | 3.355 202 |
| schuett phoenix II accu with sensor, integrated high-power battery (foot-switch optional) | 3.356 202 |

Accessories

| | |
|--|-----------------------|
| Foot-switch stainless steel (works in 2 operation modes), 3500 mm cable length** | 3.358 392 |
| Glass spatter guard, to work with pathogene materials | 3.358 332 |
| Windshield stainless steel, to protect the flame from sideway currents | 3.358 342 |
| Instrument tray stainless steel, with 5 holding spaces | 3.358 352 |
| Hot-Tray stainless steel for use in chemistry laboratories, 160x140x160 mm (w x h x d), height-optimized | 3.358 362 |
| Cable for the connection to 12 V (car cigarette lighter) | 3.358 382 |
| Pressure reducer for 5 kg and 11 kg propane gas bottles (TÜV-certified, indoor/outdoor) | 3.358 302 |
| Gas-safety hose for natural gas 1/2" for the connection to a gas-outlet with thermal shut-off device (TAE) (1,0 m / 2,0 m)** | 3.358 512 / 3.358 522 |

Gas safety hoses

| | |
|--|-----------------------------------|
| for natural gas (0.75 m / 1.5 m / 2.0 m)** | 3.359 212 / 3.359 222 / 3.359 232 |
| for propane/butane gas, with threaded connection (0.5 m / 2.0 m)** | 3.359 272 / 3.359 282 |

Adapter incl. pressure reducer for the connection

| | |
|-------------------------------|-----------|
| of gas cartridges CV 360 | 3.357 212 |
| of gas cartridges Express 444 | 3.357 362 |

Adapter incl. pressure reducer and gas safety hose (0.5 m) for the connection

| | |
|---|-----------|
| of gas cartridges C 206 | 3.357 232 |
| of gas cartridges CV 270 / CV 300 / CV 470 | 3.357 252 |
| of gas cartridges CP 250 | 3.357 302 |
| of gas cartridges CG 1750 | 3.357 322 |
| of gas cartridges CG 901, CG 904 and CG 907 | 3.357 342 |

Gas cartridges (GGVSEB 2/5 F, UN 2037, LQ 2)

| | |
|--|-----------|
| Gas cartridges CV 360, with valve, 52 g/cartridge butane gas (qty=6) | 3.351 322 |
| Gas cartridges C 206, without valve (Piercable cartridge), 190 g/cartridge butane gas (qty=6) | 3.351 332 |
| Gas cartridges CV 470, with valve, 450 g/cartridge butane gas (qty=3) | 3.351 342 |
| Gas cartridges CG 1750, with screw-valve, 175 g/cartridge propane/butane gas (qty=6) | 3.351 352 |
| Gas cartridges CP 250, with valve, 250 g/cartridge butane gas (qty=6) | 3.351 362 |
| Gas cartridges CV 270, with valve, 230 g/cartridge propane/butane gas (qty=6) | 3.351 372 |
| Gas cartridges CV 300, with valve, 240 g/cartridge propane/butane gas (qty=6) | 3.351 392 |
| Gas cartridges Express 444, with valve, 60 g/cartridge propane/butane gas (qty=6) | 3.351 382 |
| Stainless steel holder for mobile sterilizer or cartridges for safely holding gas cartridges, e.g. CG 1750, CP 250 | 3.359 202 |

Spare parts

| | |
|---|-----------|
| Burner head (standard) | 3.935 700 |
| Burner head (long) | 3.935 710 |
| Universal plug-in power supply (eco, standard), 100-240 V, 50/60 Hz, worldwide (incl. set of exchange plugs - Euro, UK, US, Australien) | 3.935 800 |
| Universal battery charger (accu), 100-240 V, 50/60 Hz, worldwide (incl. set of exchange plugs - Euro, UK, US, Australien) | 3.935 810 |
| Spare-part nozzle for propane/butane gas | 3.935 730 |
| Spare-part nozzle for natural gas | 3.935 740 |
| Spare-part olive-shaped hose coupling | 3.935 790 |
| Adapter for natural gas connection 1/2" (France) | 3.934 192 |

Flame sterilizing carousel schuett easyloop, semi-automated (schuett flammy R, fully automated)

| | |
|------------------------------------|--|
| Line/mains voltage power supply | 110-240 V AC +/- 5 %, 50-60 Hz (230 V / 115 V AC, +/- 5 %, 50-60 Hz) |
| Connected voltage schuett flammy R | 6 V / DC (9 V / DC, 500 mA) |
| Dimensions (w x h x d) | 150 x 315 x 190 mm (100 x 345 x 160 mm) |
| Weight | approx. 900 g (approx. 2,000 g) |

Ordering information

| | |
|---|-----------|
| schuett easyloop Semi-automated Flame sterilizing carousel, line/mains voltage power supply | 3.353 202 |
| schuett flammy R Flame sterilizing carousel incl. 5 inoculating loop holders, line/mains voltage power supply | 3.353 102 |
| Glass spatter guard (with cut-outs), to work with pathogene materials (for both models) | 3.353 232 |

schuett easyflame Flame sterilizer

| | |
|------------------------|------------------|
| Dimensions (w x h x d) | 260 x 90 x 60 mm |
| Weight | approx. 350 g |

Ordering information

| | |
|---|-----------|
| schuett easyflame Flame sterilizer to use with propane/butane gas | 3.359 102 |
| schuett easyflame plus Flame sterilizer to use with natural gas or propane/butane gas (1/4" left-hand thread) | 3.359 112 |
| schuett easyflame CV 360 adapter (for operation with 3.359 102) | 3.359 502 |
| schuett easyflame CP 250 adapter (for operation with 3.359 102) | 3.359 602 |
| schuett easyflame rack, made of plastic, black, for cartridges | 3.359 302 |

** additional lengths on request

schuett**biotec**.de

Rudolf-Wissell-Straße 13,
D-37079 Göttingen, Germany
Phone +49 (0)551/50 410-0
Fax +49 (0)551/50 410-99
e-mail: info@schuett-biotec.de
www.schuett-biotec.de



Delivery extent schuett phoenix II standard:

Sensor feature with 1x/2x operation / Adjustment of sensitivity and indicator lamps / Operating mode hand / Foot-switch feature / LED-Colour-Display - burn-time, information and warning remarks in 13 languages / Joystick-navigation / Universal plug-in power supply, incl. set of exchange plugs (worldwide) / Olive-shaped hose coupling / Nozzles for natural gas and propane/butane gas / Tilting / Removable burner head (no need for tools) / Operating instructions / Warranty

Glasses, bottles & caps

Storage and Closure



Culture tubes and glasses

Culture bottles for the cultivation, transport and long-term storage

We offer a large variety of culture glasses and bottles with screw caps.

Our vessels are especially suitable for transport, despatch and long-term storage.

The glasses are delivered completely with screw cap made of aluminium respectively plastic including a rubber gasket.

Aluminium screw cap

- autoclavable
- sterilizable

Plastic screw cap

- steam-autoclavable at 121 °C
- sterilizable

Replacement screw caps available for

- Test tubes
- Culture tubes
- Culture bottles

Culture tubes with screw cap



Made of soda-lime glass, partly with frosted labeling space.

Storage cases for culture tubes

Different cases are available for storage and transport of culture tubes.



Storage case P.

Made of polystyrene.
For 50 glasses 35 x 12 mm.

Storage case PP, autoclavable.

Made of polypropylene.
For 50 culture tubes 35 x 12 mm.



Storage case H. Made of wood.
For 100 glasses 50 x 14 mm.



Storage case "box", autoclavable up to 121 °C.

Made of polypropylene.
For 49 culture tubes 50 x 14 mm, black, with slip lid, stackable.

Test tubes with screw cap



Made of borosilicate glass, strong-walled, 1.1 mm.
The wide neck makes it easy to inoculate and clean.

Culture bottles, flat, octagonal



Culture bottles, round



Made of clear glass.
DIN-standard.

Cultivation glasses



The roundrim glasses with straight sidewalls and loose lids are designed for cultivation of cell cultures.

The glasses stand firmly on the bottom even when empty and are stackable to save space.

Available with 250, 500 or 750 ml capacity. The covers can be fixed with metal clamps (optional).

Caps

Caps for sterile closing of vessels

Microbiological, bacteriological and biotechnical laboratories have various needs to seal test tubes or other glass or plastic vessels.

We offer a large range of caps in different sizes and styles.

Advantages of our caps

- stainless
- washable/reusable
- heat-resistant
- sterilizable
- tight sealing
- air circulation is warranted
- different colours for recognition

Recommendation for cleaning

The anodic oxidized coloured eloxal film of the aluminium caps is not resistant to alkaline detergents.

Therefore, we recommend the use of neutral cleaning supplies for cleaning, e.g. Extran MA02 neutral or P3 neutropon 5003, available on request.

Maximum temperature 140 °C.

Made of aluminium, anodized in colour, anodic oxidized. Springs made of chromium-nickel-steel.

LABOCAP-caps with handle



With clamp against the outer wall of the vessel.

LABOCAP-caps without handle



With clamp against the outer wall of the vessel.

ERLENMEYER-CAP-caps



With clamp against the outer wall of the vessel. Special caps for culture flasks and culture media bottles with straight neck of Ø 38 mm.

Made of pure aluminium, matt-finished, without spring.

ALU-STECK-caps



For placing loosely on top of vessels. Also suitable as open test vessels for a variety of other applications.

Ordering Information and Cat-No.**ALU-STECK-caps**

| Inner-Ø | Height | qty | silver |
|---------|--------|-----|-----------|
| 11 mm | 25 mm | 100 | 3.620 113 |
| 12 mm | 25 mm | 100 | 3.620 213 |
| 13 mm | 25 mm | 100 | 3.620 313 |
| 14 mm | 25 mm | 100 | 3.620 413 |
| 15 mm | 25 mm | 100 | 3.620 513 |
| 16 mm | 30 mm | 100 | 3.620 613 |
| 17 mm | 30 mm | 100 | 3.620 713 |
| 18 mm | 30 mm | 100 | 3.620 813 |

(continued in next column)

| Inner-Ø | Height | qty | silver |
|---------|--------|-----|-----------|
| 20 mm | 30 mm | 100 | 3.620 913 |
| 22 mm | 30 mm | 100 | 3.621 113 |
| 28 mm | 30 mm | 100 | 3.621 213 |
| 32 mm | 30 mm | 100 | 3.621 313 |
| 39 mm | 30 mm | 10 | 3.621 413 |
| 44 mm | 40 mm | 10 | 3.621 513 |
| 48 mm | 40 mm | 10 | 3.621 613 |
| 55 mm | 40 mm | 10 | 3.621 713 |
| 58 mm | 40 mm | 10 | 3.621 813 |

LABOCAP-caps with handle

| For glasses | qty | silver | blue | red | yellow | green | black | violet |
|-------------|-----|------------|------------|------------|-----------|-----------|-----------|-----------|
| 12/13 mm | 100 | 3.623 113* | - | - | - | - | - | - |
| 15/16 mm | 100 | 3.623 313 | 3.623 323 | 3.623 333 | 3.623 343 | 3.623 353 | 3.623 373 | 3.623 383 |
| 17/18 mm | 100 | 3.623 413 | 3.623 423 | 3.623 433 | 3.623 443 | 3.623 453 | 3.623 473 | 3.623 483 |
| 19/20 mm | 100 | 3.623 513* | 3.623 523* | 3.623 533* | - | - | - | - |

LABOCAP-caps without handle

| For glasses | qty | silver | blue | red | yellow | green | black | violet |
|-------------|-----|-----------|-----------|-----------|-----------|-----------|-----------|-----------|
| 09/10 mm | 100 | 3.624 113 | 3.624 123 | 3.624 133 | ** | ** | ** | ** |
| 12/13 mm | 100 | 3.624 213 | 3.624 223 | 3.624 233 | 3.624 243 | 3.624 253 | 3.624 273 | 3.624 283 |
| 14/15 mm | 100 | 3.624 313 | 3.624 323 | 3.624 333 | ** | ** | ** | ** |
| 15/16 mm | 100 | 3.624 413 | 3.624 423 | 3.624 433 | 3.624 443 | 3.624 453 | 3.624 473 | 3.624 483 |
| 17/18 mm | 100 | 3.624 513 | 3.624 523 | 3.624 533 | 3.624 543 | 3.624 553 | 3.624 573 | 3.624 583 |
| 19/20 mm | 100 | 3.624 613 | 3.624 623 | 3.624 633 | 3.624 643 | 3.624 653 | 3.624 673 | 3.624 683 |
| 21/23 mm | 100 | 3.624 713 | 3.624 723 | 3.624 733 | ** | ** | ** | ** |
| 24/26 mm | 100 | 3.624 813 | 3.624 823 | 3.624 833 | ** | ** | ** | ** |
| 28/30 mm | 100 | 3.624 913 | 3.624 923 | 3.624 933 | ** | ** | ** | ** |

Other colours are available on special request

ERLENMEYER-CAP-caps

| For glasses | qty | silver | blue | red |
|-------------|-----|-----------|-----------|-----------|
| 37/39 mm | 10 | 3.627 113 | 3.627 123 | 3.627 133 |

Test tubes with screw cap (qty=100)

| | | Aluminium | Plastic | Aluminium | Plastic |
|-------------|---------------|-----------|-----------|-----------|-----------|
| 98 x 16 mm | approx. 15 ml | 3.560 103 | 3.561 103 | 3.569 173 | 3.570 173 |
| 150 x 16 mm | approx. 20 ml | 3.560 163 | 3.561 163 | 3.569 173 | 3.570 173 |
| 150 x 25 mm | approx. 50 ml | - | 3.561 253 | - | 3.570 243 |

Culture tubes with screw cap (qty=100)

| | | Aluminium | Plastic | Aluminium | Plastic |
|--|---------------|-----------|-----------|-----------|-----------|
| 35 x 12 mm | approx. 3 ml | 3.562 123 | - | 3.569 123 | - |
| 50 x 14 mm (with frosted labeling space) | approx. 5 ml | 3.562 143 | 3.563 143 | 3.569 143 | 3.570 143 |
| 45 x 27 mm | approx. 15 ml | 3.562 423 | 3.563 423 | - | 3.570 253 |
| 50 x 27 mm | approx. 20 ml | 3.562 523 | 3.563 523 | - | 3.570 253 |
| 75 x 27 mm | approx. 30 ml | 3.562 623 | 3.563 623 | - | 3.570 253 |

Storage case for culture tubes

| | |
|---|-----------|
| Storage case P (for 50 culture tubes 35 x 12 mm) | 3.564 123 |
| Storage case PP (whitely) autoclavable (for 50 culture tubes 35x12 mm) | 3.564 133 |
| Storage case H (for 100 culture tubes 50 x 14 mm) | 3.564 143 |
| Storage case Box (black) autoclavable (for 49 culture tubes 50 x 14 mm) | 3.564 153 |

Culture bottles, flat, octagonal, with screw cap (qty=10)

| | Aluminium | Plastic | Aluminium | Plastic |
|--------|-----------|-----------|-----------|-----------|
| 50 ml | 3.565 053 | 3.566 053 | 3.569 223 | 3.570 223 |
| 100 ml | 3.565 103 | 3.566 103 | 3.569 223 | 3.570 223 |
| 250 ml | 3.565 253 | 3.566 253 | 3.569 223 | 3.570 223 |

Culture bottles, round, with screw cap (qty=10)

| | Aluminium | Plastic | Aluminium | Plastic |
|---------|------------|------------|-----------|-----------|
| 30 ml | 3.567 033 | 3.568 033 | 3.569 183 | 3.570 183 |
| 50 ml | 3.567 053 | 3.568 053 | 3.569 183 | 3.570 183 |
| 100 ml | 3.567 103 | 3.568 103 | 3.569 223 | 3.570 223 |
| 250 ml | 3.567 253 | 3.568 253 | 3.569 223 | 3.570 223 |
| 500 ml | 3.567 503* | 3.568 503* | - | 3.570 253 |
| 1000 ml | 3.567 993* | 3.568 993* | 3.569 283 | - |

Cultivation glasses (qty=6)

| | |
|------------------------|-----------|
| 250 ml | 3.571 253 |
| 500 ml | 3.571 503 |
| 750 ml | 3.571 753 |
| Clamps, metal (qty=20) | 3.571 993 |

*No longer available when stock is sold out.

**Special colours available on request, in larger packaging units.

schuett**biotec**.de

Rudolf-Wissell-Straße 13, D-37079 Göttingen, Germany
 Fon +49 (0) 551/5 04 10-0, Fax +49 (0) 551/5 04 10-99
 info@schuett-biotec.de, www.schuett-biotec.de

schuett count

manual colony counter

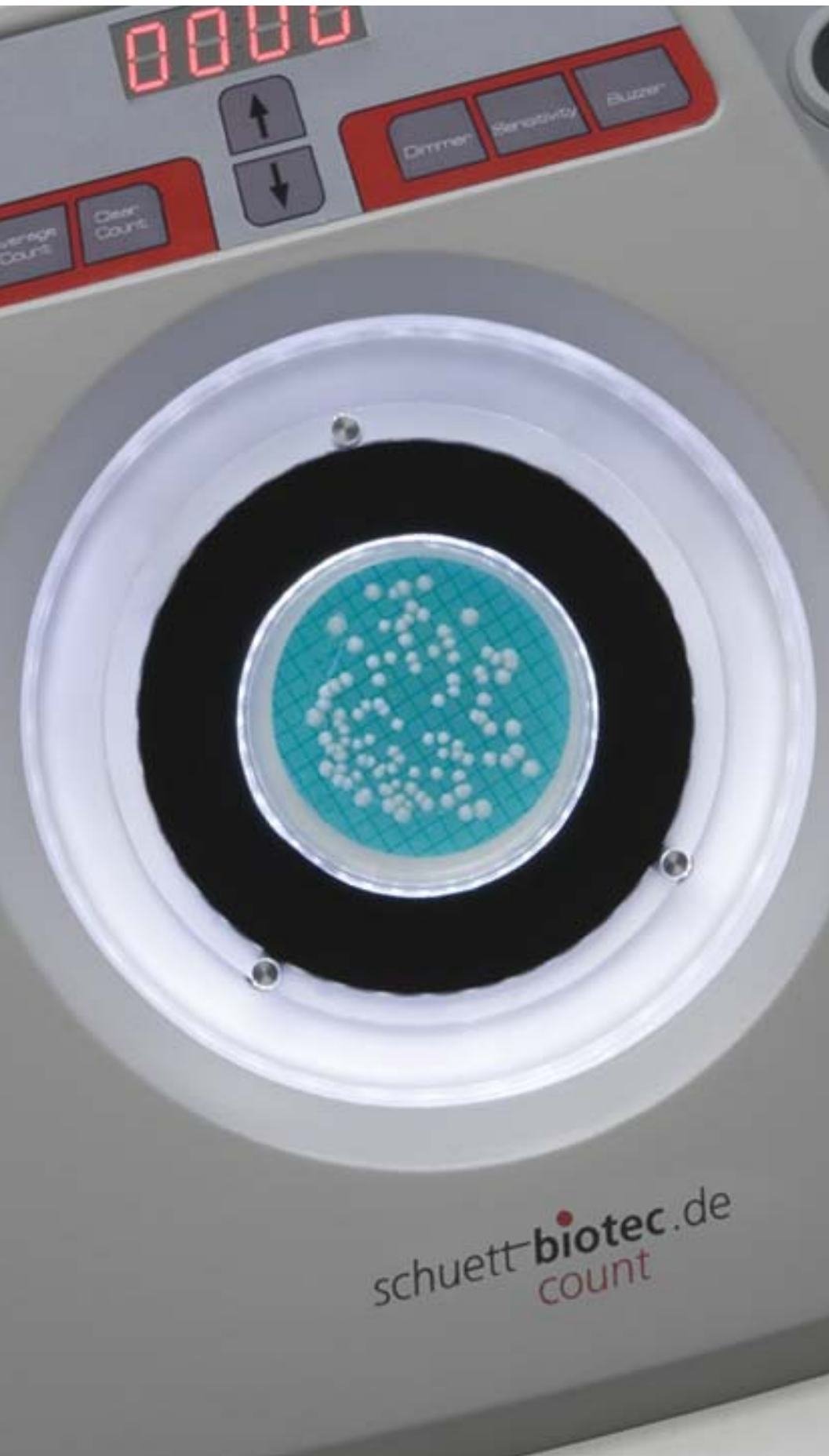



schuett count colony counter

Usually, the most time-consuming part in microbial analysis is counting Petri dishes. The schuett count colony counter was designed to facilitate this task considerably and will become essential equipment in your microbiological laboratory.

Easy, rapid and reliable counting of bacterial colonies is no longer trouble when using this device.

The schuett count colony counter is suitable for reliable and efficient counting of

- bacterial colonies growing on nutrient agar in Petri dishes of 60 to 150 mm diameter
- bacterial colonies growing on filter disks/agar or nutrient disks
- phage plaques growing on agar

Transparent medium or filter disks/agar: two special adapters for inserting Petri dishes allow for ideal height positioning of the dishes in order to reach optimum lateral illumination.

The power supply provides an automatic line/mains supply identification 100-240 VAC compensating short voltage breakdowns.

- **three modes of illumination:**
 - from below
 - from the side and
 - from top (optional)
- **Petri dishes or nutrient disks with**
 - Ø 90 mm
 - Ø 60 mm or Ø 150 mm (optional)
- **high transparency of colonies reached by LED-light source, practically no heat transferred to the sample**
- **light intensity, pressure sensitivity for count and acoustical counting signal adjustable**
- **average determination**
- **data transfer via USB to the PC**

The schuett count may be used for a large variety of applications where microbial checks are needed:

- in bacteriology
- in dairy and beverage industry
- in Medical Test Centres
- in Quality Control for water treatment plants
- in food and environmental analytics

The counter is initiated by marking the colonies with an ordinary felt-tip marker pen.

The Petri dish holder is pressure sensitive. Already a gentle touch of the Petri dish with the pen generates a count.

The result is clearly shown on a large 4-digit LED-display (0-9999) with reset feature.

A well-organized and easy to clean keypad allows for nearly **infinite, reproducible adjustment (for each operator) of pressure sensitivity, light intensity and acoustical count signal**. The corresponding level of sensitivity is shown in the digital display.

The count signal acoustically confirms the count of a colony.

Correction of counting mistakes is easily possible by adding or subtracting with the arrow keys. When counting high numbers of colonies, the optional Wolffhügel-disk facilitates the segmenting in the bright or the dark field.

A black contrast disk for working in dark fields is included in the delivery extent.



Illumination of colonies

Illumination of colonies

State-of-the-art light technology allows for circularly illuminating the colonies from the side resulting in a transparency and differentiation of the colonies never possible before.

There is no stray light or blinding, which is usually a problem when using fluorescent lamps.

In addition, the dimming feature allows for adjusting the light intensity to the needs of the user and accounts for surrounding light inside the lab.

A natural colour reproduction facilitates differentiation between various coloured cultures growing on chromogenic medium and filter/nutrient disks.

The state-of-the-art illumination provides such a contrast that agar plates, with colonies growing on and inside the agar may easily be counted.

As a result, eyestrain is reduced to a minimum allowing for extended periods of uninterrupted work.

The entire illumination consumes only 3 Watts producing practically no heat.

Choose individually the ideal mode of illumination according to the medium.

Use the bright background for dark colonies or the black contrast disk for light colonies.



Illumination from below

Three modes of illumination

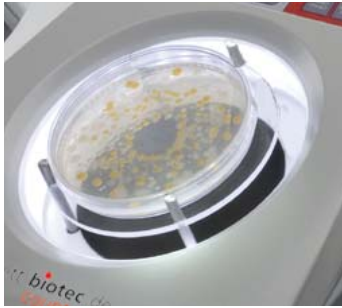

1) Illumination from below

White colonies growing in and on clear agar are illuminated from below in order to avoid reflections.

The glarefree illumination facilitates the counting of the colonies especially at the rim of the Petri dish.

Differentiation between colonies and air bubbles inside the agar is possible without any difficulties.

Furthermore, the light source allows for the correct identification of mucus secreting colonies and observing the decrease of turbidity caused by calcium carbonate inside the agar when working with acid producing micro-organisms.

Example:

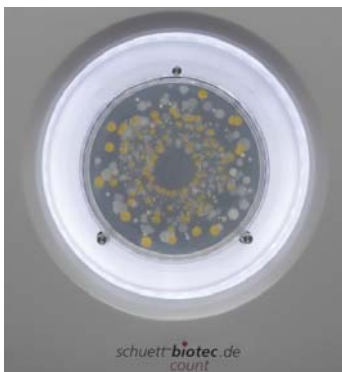

Light colonies on clear agar in the dark field.

Illumination from the side



2) Illumination from the side

For colonies growing on filter disks and on non-transparent agar, the illumination from the side has been developed.

Transparent colonies are mostly 3-dimensional.

Accurate colour reproduction of the colonies in the bright and dark field is reached, so that an incredible ease of work is reached for all agar media where a colour differentiation of various colony colours is requested.

The direct lateral illumination in conjunction with the white light spectrum of the LEDs lights up, colonies that may hardly be seen in the reflecting light of fluorescent lamps.

Example:



Various coloured colonies on filter disk with adapter for Petri dishes with \varnothing 50-60 mm.

Illumination from top



3) Illumination from top (optional)

For colonies with a very low contrast to the background and colonies growing on dark agar, we optionally offer a LED-top light lamp for connection to the standard schuett count manual colony counter.

The top light lamp is equipped with a flexible gooseneck and illuminates the complete Petri dish. It is especially suggested for counting very small colonies.

Example:



White colonies on green filter disk with top illumination.

Average determination

Average determination

For serial tests, the schuett count may show the average by push of a button.

Up to 99 values with a total of max. 32,500 colonies may be evaluated.

USB-data transfer

USB-data transfer

schuett count provides a USB-interface, which may transfer the counting result directly to an Excel-chart or field of the analysis report.

Ergonomically shaped

Ergonomically optimized

The inclination of the instrument's working surface is optimized for the operator, so that the Petri dish is positioned as horizontally as possible without forcing the user to bend over the instrument.

The convenient width of the schuett count allows for positioning both hands onto the instrument without blocking additional working space.

These construction features support easy and comfortable work.

Due to the compact construction, the schuett count only requires little space.

The housing is easy to clean.



Accessories

Magnifying glass (gooseneck)



With 3-fold magnification, and connector for schuett count, for individual adjustment of the perspective, movable and inclinable. Additional magnifying glass (Ø 1.3 cm) with 10-fold magnification, integrated into the gooseneck, only for inspection of single colonies.

LED-top light lamp (gooseneck)



With connector for schuett count, for individual adjustment of the lighting angle, movable and inclinable, for optimum additional illumination of the colonies.

Adapter for Petri dishes with Ø 50-60 mm



For central positioning of Petri dishes up to Ø 60 mm.

Adapter for Petri dishes with Ø 140-150 mm



For central positioning of Petri dishes up to Ø 150 mm.

Wolffhügel-disk, Spiral-Plater-disk and contrast disk



Felt-tip marker pen and counting needle



Each ordinary felt-tip marker pen may be used for counting.

The marking of the colonies avoids omission and double-counts.

The stainless steel counting needle allows for counting the colonies directly in the agar.

For counting more than 20 Petri dishes per day and counting results of 50 to 300 colonies per Petri dish, we suggest:

schuett colonyQuant - automated colony counter.

For details information, please request our separate data-sheet schuett colonyQuant.

Technical data

| | |
|---|--|
| Dimensions (w x h x d): | 280 x 130 x 250 mm |
| Height with gooseneck magnifying glass/top light lamp | approx. 300 mm |
| Magnification (optional): | 3x or 6-8x |
| LED-Display: | 4-digit (0-9999) |
| Size of Petri dish (Ø) | 50-60, 90-100 or 140-150 mm (optional) |
| Reset/down counts/correction of counting mistakes: | yes |
| Pressure sensitivity: | yes (adjustable) |
| Light intensity: | LED-lighting technology (dimnable) |
| Count signal (buzzer): | yes (adjustable) |
| Weight: | 1.5 kg |
| Protection class: | III |
| IP: | 30 |
| Wall power supply: | 100-240 V / 50-60 Hz |
| Power input: | 5 V DC, 2100 mA; 7,5 W |

Ordering information**Cat.-No.**

| | |
|--|------------------|
| schuett count colony counter, 100-240 V, incl. felt-tip marker pen, adapter for Petri dishes with Ø 90 mm and contrast-disk (black) | 3.081 502 |
|--|------------------|

Accessories

| | |
|---|------------------|
| Magnifying glass, 3x for 3-fold magnification of the complete Petri dish, incl. magnifying glass (Ø 1.3 cm) with 10-fold magnification, only for inspection of single colonies, incl. gooseneck support, individually adjustable, Ø 100 mm | 3.081 602 |
| Magnifying glass, 6-8x for 6-8-fold magnification of the complete Petri dish incl. gooseneck support individually adjustable, Ø 60 mm | 3.081 612 |
| LED-top light lamp for optimum illumination of cultures, incl. gooseneck support | 3.081 702 |
| Adapter for Petri dishes with Ø 50-60 mm for central positioning | 3.081 802 |
| Adapter for Petri dishes with Ø 140-150 mm for central positioning | 3.081 812 |
| Spiral-Plater-disk, black/white for counting with Spiral-Plater-method | 3.081 902 |
| Wolffhügel-disk, black/white for sectoral counting of Petri dish | 3.081 912 |
| Counting needle for counting by tap of the colony | 3.081 922 |
| Felt-tip marker pen (water-resistant) | 3.081 932 |
| USB connection cable for PC | 3.081 992 |

schuett **biotec**.de

Rudolf-Wissell-Straße 13, D-37079 Göttingen, Germany
Fon +49 (0) 551/5 04 10-0, Fax +49 (0) 551/5 04 10-99
info@schuett-biotec.de
www.schuett-biotec.de

schuett colonyQuant



rapid and reliable counting

schuett colonyQuant
automated colony counter system

- Software for selection according to colour, size and shape
- Light-proof sample chamber with high-definition camera (colour), Live-image and circular LED-illumination
- Image acquisition and simultaneous evaluation within seconds
- Tables and images may be stored digitally, results for each counted colony reviewable
- Agar plates, nutrient disks, filters, plaque assays, inhibition zone analysis, spiral plating, drop plates, „lanes“, fluorescence
- Mixed cultures, separates up to 8 colours simultaneously
- Sectorial evaluation, 90% option
- In conformity with GLP, LIMS-compatible

schuett colonyQuant is the economic solution for evaluating Petri dishes at high demand on daily sample throughput rates. Image acquisition and analysing the colonies at the push of a button. Changeover from evaluating agar plates to nutrient filter disks etc. can be effected quickly by mouse-click without difficulties.



Multifunctional and time-saving

Effective

The sample chamber with an attractive design, needs only small footprint.

Software will be delivered pre-installed on PC/Laptop, standard demo settings are stored, this allows immediate operation.

Time-saving

Significantly increases efficiency compared to manual evaluation of the colonies.

400 Petri dishes per hour, independent of 10 or 1,000 colonies growing on the sample.

No counting errors as they occur with declining concentration when counting manually.

Universal

schuett colonyQuant was designed for Quality Control in food, beverage and pharmaceutical industries, in microbiological test labs. The colonyQuant system is ideal for evaluation of Ames tests and water samples.

The system may be set and calibrated to different types of colonies and agars/nutrient disks within minutes.

The reasoned software in German and English language helps analysing and differentiating colonies by colour, size and shape.

The settings may be changed at any time according to the users request and the system shows the effects on the counting result immediately. The original image, the evaluated image as well as the set parameters may be stored and re-opened at any time by using the file name.

The Windows based structure of the software/icons makes it easy for the operator to comprehend the system's functions.

The device centres Petri dishes Ø 60 to Ø 90 mm exactly and reproducibly. The camera automatically zooms to ensure that also Ø 60 mm Petri dishes are evaluated with high resolution.

Facilitates Quality Control

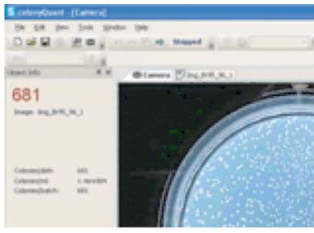

State-of-the-art LED-lighting technology assures a lateral illumination of the Petri dish and results in so far unknown transparency and differentiation of the colonies on the agar.

Filters are illuminated from above for maximum contrast and colour differentiation. The grid on filter disks may be removed easily in the colonyQuant-software and will not adulterate the result.

Spiral plating dishes are counted automatically in consideration of the counting grid.

Inhibition zones are analysed clockwise.

Data storage (documentation)

The original image and the evaluated image are stored digitally, all relevant data of the analysis are automatically stored for later re-evaluation.

An analysis report may be printed, the user may decide which individual parameters are of need. Elimination of transcription errors. All results are presented in a table, exportable to Excel- or CVS-format. All data may be exported to a LIM-system.

Efficient

The counting settings are to be adjusted only once for each type of colony. The area to be counted is defined prior to analysis. If the rim of the Petri dish is difficult to evaluate, the software counts 90% of the Petri dish and extrapolates the total number of colonies. The software also allows for counting individual quarters of the total area. Further, the „lasso“-function allows counting of certain defined areas of the Petri dish.

After entering the volume and dilution, the colonies per ml are calculated automatically.

Counting different colonies simultaneously

The counting result may be corrected manually at any time by using the "Add"/"Delete"-function.

Helpful features

Measurements:

Distances and areas may be measured and are shown in a separate list.

Inscriptions:

Make your own notes in free text fields and save them in the image.

Criteria for differentiation (may be combined as needed).

Colour:

The differentiation of coloured colonies (e.g. flavine containing or colouring by chromogenic, selective agar) compared to colourless colonies may be obtained by defining the actual intensity-spectrum of the corresponding colour. In total there is a maximum of eight different colour gradients to be set. This means blue and red colonies may be counted simultaneously on one Petri dish and the result will show the total of blue colonies or the total of red colonies and total count of both.

Size:

The differentiation of colonies with different sizes is also possible, e.g. large colonies may be differentiated from the background growth.

The minimum colony size for counting is 0.05 mm.

Shape:

By differentiating colonies according to their shape it is possible to define the roundness of the colonies to be counted.

This is helpful for analysing bacterial colonies on agar plates in the presence of moulds or precipitates of the same colour.

Copes with all challenges

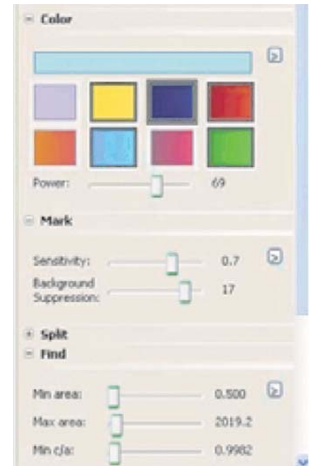

Overlapping

The split function allows for gradually separating overlapping colonies. This is particularly advantageous with Petri dishes having a large number of colonies or with bigger colonies.

In conformity with GLP

All sensitive areas are password protected. The software is structured in three levels:

- administrator
- controller
- operator

The administrator may decide which counting parameters are to be addressed by the operator.

Name of the operator, batch and sample number are automatically stored with the result of the analysis.

Provision for system check with a coloured disk (provided with the system) and reset function to recall manufacturer provided standard settings.

| Imagefile | Objects | Obj.Cat 1 | Obj.Cat 2 | Obj.Cat 3 | Obj.Cat 4 | Relativearea % | Date/Time | Imagefile |
|--------------------------------------|---------|-----------|-----------|-----------|-----------|----------------|-------------------|--------------------|
| 11:58:05 15:36:49 Ing_Bursten 32_564 | 43 | 5 | 33 | 1 | 4 | 3.05 | 11:58:05 15:36:49 | Ing_Bursten 32_564 |
| 11:58:05 15:38:18 Ing_Bursten 32_565 | 46 | 5 | 37 | 1 | 3 | 2.44 | 11:58:05 15:38:18 | Ing_Bursten 32_565 |
| 11:58:05 15:39:57 Ing_Bursten 32_566 | 47 | 5 | 36 | 1 | 5 | 2.84 | 11:58:05 15:39:57 | Ing_Bursten 32_566 |
| 11:58:05 15:39:25 Ing_Bursten 32_567 | 43 | 5 | 34 | 1 | 3 | 2.46 | 11:58:05 15:39:25 | Ing_Bursten 32_567 |
| 11:58:05 15:39:42 Ing_Bursten 32_568 | 46 | 5 | 36 | 1 | 4 | 2.42 | 11:58:05 15:39:42 | Ing_Bursten 32_568 |
| 11:58:05 15:40:20 Ing_Bursten 32_569 | 46 | 5 | 36 | 1 | 4 | 2.49 | 11:58:05 15:40:20 | Ing_Bursten 32_569 |
| 11:58:05 15:40:43 Ing_Bursten 32_570 | 46 | 5 | 35 | 1 | 5 | 2.83 | 11:58:05 15:40:43 | Ing_Bursten 32_570 |
| 11:58:05 15:41:11 Ing_Bursten 32_571 | 49 | 5 | 40 | 1 | 3 | 2.51 | 11:58:05 15:41:11 | Ing_Bursten 32_571 |
| 11:58:05 15:41:27 Ing_Bursten 32_572 | 42 | 5 | 33 | 1 | 3 | 2.71 | 11:58:05 15:41:27 | Ing_Bursten 32_572 |
| 11:58:05 15:41:47 Ing_Bursten 32_573 | 41 | 5 | 33 | 1 | 4 | 3.45 | 11:58:05 15:41:47 | Ing_Bursten 32_573 |

Data and facts

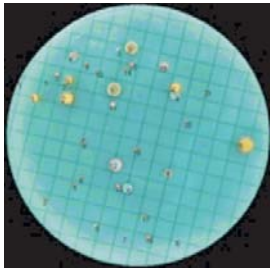

Total numbers of colonies

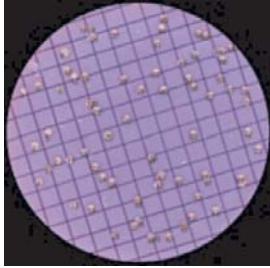

Enterobacteria

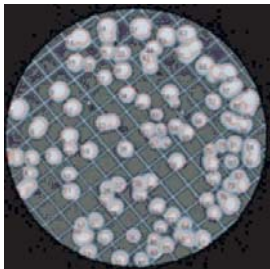

Brewer's yeast

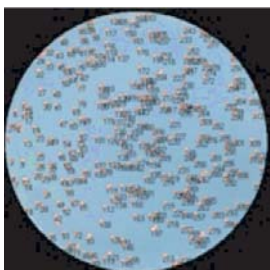

E. coli colonies on LB-agar

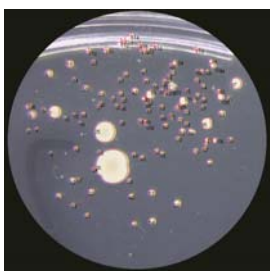

Drop plate

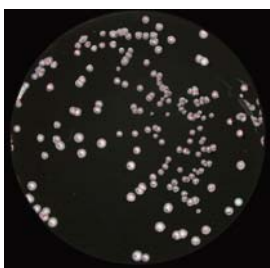

Legionella

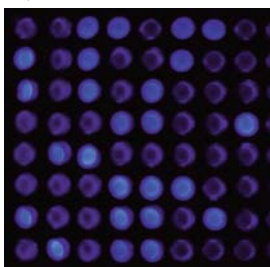

MPN test in microwell plate

Typical Applications

Total number of colonies: All colonies will be counted, even if they differ in colour, size and shape.

Enterobacteria: E. coli colonies are of a light cream colour and not much different from the transparent slightly yellow colour of the LB-agar itself, but can easily be counted with the lateral LED-illumination.

Filters on agar or nutrient disks: Colonies growing on filter disks are perfectly illuminated from above. The grid being shown on the surface of the filter will be ignored by the software and does not affect the counting result. Clear colonies become visible by illumination from the side at the middle level of the sample chamber.

High number of colonies: Up to approx. 1,000 colonies per Petri dish will be count within seconds.

Bacteriophage plaque assays: By using the dark field it is feasible to count plaques against a cell background.

Agar: Cloudy/clear, all colours, plates with sloped agar (uneven thickness).

Fluorescence: Evaluation of fluorescent colonies illuminated with UV light, e.g. for MPN tests in microwell plates.

Technical Data

Camera:

HD3 - USB 3.0

HD1080i color camera, with autozoom/-focus; 3x optical/12x digital zoom

HD10 - HDMI

HD1080i color camera, with autozoom/-focus; 10x optical/12x digital zoom

Resolution of the monitor:

HD3 and HD10

1920 x 1080 Laptop; 1920 x 1080 or 1920 x 1200 (24" monitor)

Data transfer:

HD3

USB 3.0 (PC or Laptop)

HD10

HDMI with HDMI I/O card (PC only)

Light-proof sample chamber

prevents from reflections and outside light with adjustable guide rails for Petri dishes

Illumination (3 sections)

selectable from above, from the side or from below (3 levels)
Background black or white

Fluorescence-UV-light source

366 nm

Software

colonyQuant counting software (windows user interface, Windows® 7 Professional (English version)
Open office (or similar)

Accessories (scope of delivery)

System check disk, inlaid glass plate, centring devices, contrast plate for white or black background, Petri Dish carrier made of Plexiglas/ground clear (Greiner/Falcon)

Accessories (optional)

Barcode scanner
Adapter for MPN analysis in microwell plates
Adapter for Drop plates; Adapter for plates with „lanes“
Adapter for Petrifilm®

Dimensions (w x h x d)

240 x 479 x 290 mm

Weight

approx. 11 kg

Supply voltage

100-240 VAC, 50-60 Hz, 60 W

Ordering Information

Cat.-No.

schuett colonyQuant automated colony counter, 230 V, for colonies with minimum-Ø of 0.05 mm.

Light-proof sample chamber with 3 sample levels (illumination from top, side or below selectable) with adjustable guide rails for centring the Petri dishes, Fluorescence-UV-light source 366 nm, inlaid glass plate, reticle plate with centring, contrast disk for white or black background, system check disk, 2 Petri dish carrier made of Plexiglas/ground clear for Greiner/Falcon-Petri dishes, power cable

schuett colonyQuant HD3

Equipped with high-definition USB 3.0 colour camera autozoom/autofocus (3x optical; 12x digital)

incl. USB 3.0 adapter cable

Optional

Incl. PC/Laptop with Windows 7 operating system (optional German/English) as well as German or English keyboard and 24" monitor, incl. counting software

3.083 002

Excl. PC/Laptop, incl. counting software with Windows user interface for self installation on customer-specific PC/Laptop (according to predetermined minimum requirements) with Windows 7 operating system German/English

3.083 012

schuett colonyQuant HD10

3.084 002

Equipped with high-definition HD1080i colour camera autozoom/autofocus (10x optical; 12x digital)

incl. HDMI-connection cable, USB 2.0 adapter cable

incl. PC with Windows 7 operating system (optional German/English) as well as German or English keyboard and 24" monitor, incl. counting software

schuett **biotec**.de

Rudolf-Wissell-Straße 13, D-37079 Göttingen, Germany

Fon +49 (0) 551/5 04 10-0, Fax +49 (0) 551/5 04 10-99

info@schuett-biotec.de

www.schuett-biotec.de

Containers

For Sterilization and Storage

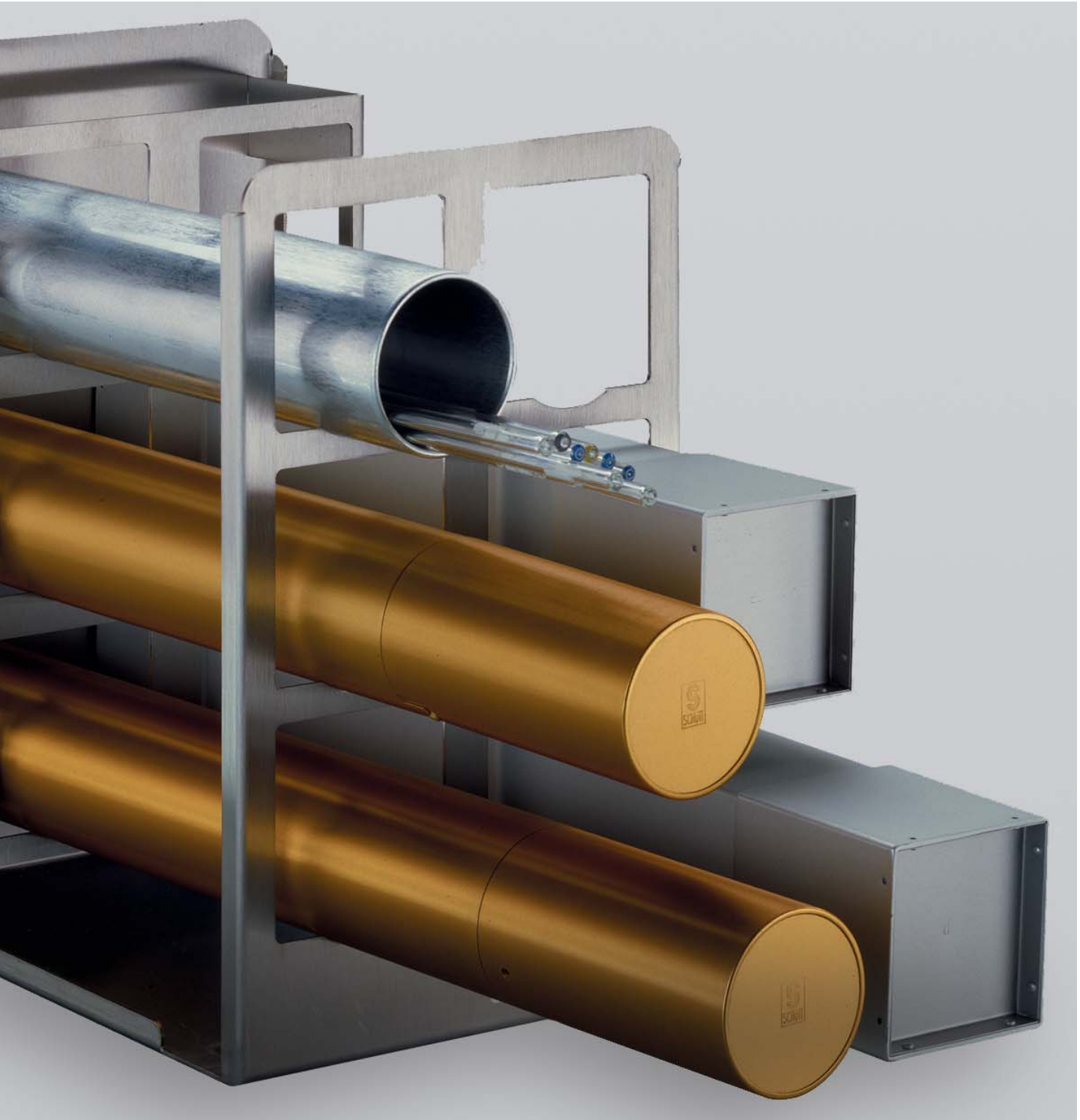

Sterilization and storage

Containers

For sterilization and storage of pipettes, pipette tips, glasses and other

Containers for sterilization are used in all areas, where pipettes, Petri dishes, pipette tips, test tubes, culture tubes or other small parts made of glass or plastic have to be sterilized or stored in a sterile environment.

The wide range of our programme of containers for sterilization surely offers an economically useful solution for your working field as well.

UNICON

UNICON Universal containers



For sterilization and storage of pipette tips and all other small parts made of glass or plastic that have to be sterilized or stored in a sterile environment.

UNICON are round and provide a comfortable slip-over lid, that may only be attached loosely during the autoclaving process. They are made of pure aluminium.

- UNICON 1
i.e. for centrifuge glasses,
- UNICON 2
i.e. for test tubes,
- UNICON 3
i.e. for pipette tip inserts,
- UNICON 4
i.e. for small parts made of glass or plastic.

Pipette tip racks

Various racks for the insertion of blue, yellow and crystal pipette tips in UNICON 3. After the sterilization, the tips can easily be taken from the racks.

The arrangement of the tips even makes it possible to take them with a multi-channel pipette.

VARICON

VARICON Variable pipette containers



This economically-priced pipette container is made of two overlapping aluminium parts.

According to the length of the pipettes the lid can be slid over the lower part, so that pipettes of different volume can be sterilized and stored.

That means only one container size is needed for all standard pipettes of 280 to 420 mm length and only one size for all short or pasteur pipettes of 145 to 235 mm length.

GESTICON

GESTICON **Racks for pipette containers**



For round pipette containers VARI-
CON or square containers with
dimensions up to 65 x 65 mm.

Pipettes of different sizes are
ready to hand at your working
place respectively in your safety
workbench.

GESTICON is available in three
sizes.

Stainless steel racks with fixed
inclination to hold 4, 6 or 8 round
or square pipette containers.

SILICON

SILICON **Silicone inserts**

For insertion into the pipette con-
tainers VARICON RS and RK.

SILICON prevents from damaging
pipettes by sudden shocks. They
are made of 2 mm thick silicone
rubber and highly elastic.

SILICON has a diameter of 58 mm
and fits in the lower part of
VARICON RS and RK.

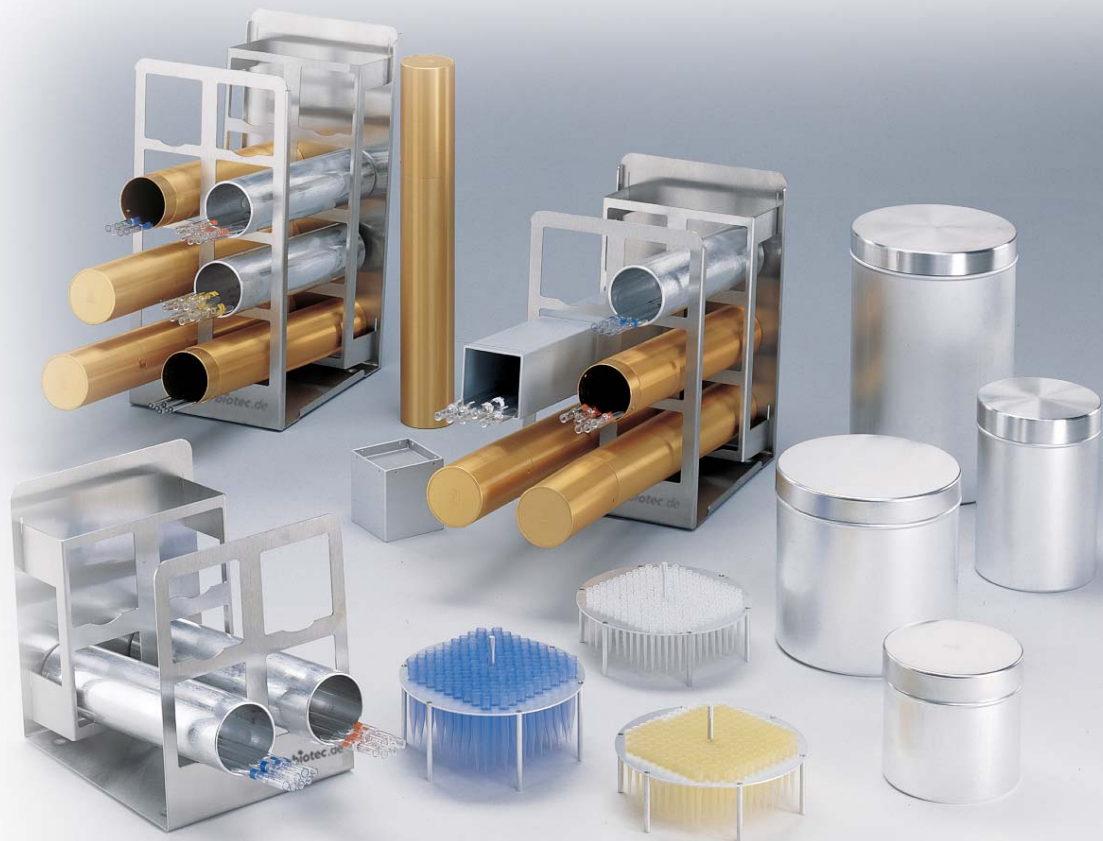

Technical Data/Ordering Information**Cat.-No.****UNICON**

| | | | |
|----------|---------------|----------|------------------|
| UNICON 1 | 115 mm height | Ø 120 mm | 3.526 113 |
| UNICON 2 | 175 mm height | Ø 120 mm | 3.526 173 |
| UNICON 3 | 170 mm height | Ø 170 mm | 3.526 183 |
| UNICON 4 | 270 mm height | Ø 170 mm | 3.526 273 |

Pipette tip rack

| | | | |
|--------|------------------------------|--|------------------|
| Rack b | for 116 blue pipette tips | | 3.527 013 |
| Rack g | for 208 yellow pipette tips | | 3.527 023 |
| Rack c | for 208 crystal pipette tips | | 3.527 033 |

VARICON

| | | | |
|------------|------------------------------|---------|------------------|
| VARICON RK | 145-235 mm length (variable) | Ø 60 mm | 3.521 233 |
| VARICON RS | 280-420 mm length (variable) | Ø 60 mm | 3.521 423 |

GESTICON

| | | | |
|-------------|--------------------------------|-----------------|------------------|
| GESTICON E4 | 195 x 229 x 235 mm (w x h x d) | stainless steel | 3.524 042 |
| GESTICON E6 | 195 x 315 x 235 mm (w x h x d) | stainless steel | 3.524 062 |
| GESTICON E8 | 195 x 405 x 235 mm (w x h x d) | stainless steel | 3.524 182 |

SILICON

| | | | |
|---------|-------------|---------|------------------|
| SILICON | 2 mm height | Ø 58 mm | 3.523 213 |
|---------|-------------|---------|------------------|

schuett  **.de**

Rudolf-Wissell-Straße 13, D-37079 Göttingen, Germany
 Fon +49 (0) 551/5 04 10-0, Fax +49 (0) 551/5 04 10-99
 info@schuett-biotec.de
 www.schuett-biotec.de

Cuvettes

Small Vessel Rinsers and Storage Container



VAKUWASCH

VAKUWASCH Cuvette and small vessel rinser

- cleans and dries glass vessels within seconds
- easy handling



VAKUWASCH simply solves the problem of cleaning or drying used glass vessels within seconds.

This procedure saves time and increases the accuracy of measuring, e.g. with cuvettes.

VAKUWASCH cleans and dries vessels or cuvettes in one step. This cleaning method avoids cullers or damage.

VAKUWASCH is made of polyethylene is practically unbreakable. The device is resistant to all detergents and solvents of daily use.

To operate VAKUWASCH all you need is a vacuum flask (with rubber stopper with bore hole and a vacuum tube) and a low vacuum.

The content of the cuvette and the rinsing water are transported into the vacuum bottle which is very advantageous when using radioactive materials or toxic substances.

The funnel of the VAKUWASCH provides in its centre a plunger with a rubber plate and a central nozzle.

Put the vessel to be cleaned with its opening onto the rubber plate and hold it there. After connecting the vacuum, pour approx. 10 ml of distilled water into the funnel. Immediately, a heavy jet of water will shoot against the vessel's bottom and drain next to the nozzle.

Naturally, you may use detergents or other cleaning agents as well.

After draining of the water, insert few drops of acetone into the funnel. By carefully pressing the vessel's bottom, a vacuum creates a sharp air stream, which dries the vessel within seconds.

Technical Data/Ordering Information

| | Cat.-No. |
|--|------------------|
| VAKUWASCH | 3.681 002 |
| Rubber stopper with bore-hole | 3.681 102 |
| Additional device for rinsing pycnometer | 3.681 202 |
| Vacuum flask, DURAN™, 500 ml | 3.681 302 |
| Vacuum tubing (per meter) | 3.681 402 |

KÜVIBOX 1

for 16 cuvettes with 10 mm path length, up to 55 mm height

3.682 103

KÜVIBOX 2

for 8 cuvettes with 10 mm path length, up to 55 mm height and
for 4 cuvettes with 20 mm path length, up to 55 mm height

3.682 223

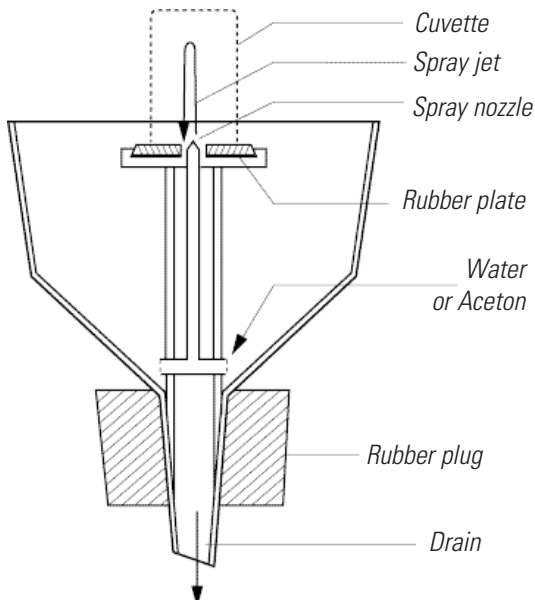

KÜVIBOX

KÜVIBOX Cuvette storage container

- protects from dust and breaking
- readily available on your working place



KÜVIBOX was designed for storage and protection from dust and breaking of cleaned cuvettes at your working place.

KÜVIBOX is available in 2 different transparent styles.

schuett **biotec**.de

Rudolf-Wissell-Straße 13, D-37079 Göttingen, Germany
Fon +49 (0) 551/5 04 10-0, Fax +49 (0) 551/5 04 10-99
info@schuett-biotec.de
www.schuett-biotec.de

EggPunch

Pneumatic Egg-Opener



Quick & Clean

EggPunch **Pneumatic egg-opener**

- **opening of 60 embryonated chicken eggs per minute**
- **clean and circular fracture**
- **sterilizable**
- **handheld**

The EggPunch pneumatic egg-opener was designed for rapid and clean opening of embryonated chicken eggs by using air pressure.

For operation, simply hold the EggPunch in your hand and put your thumb on the trigger button. Pushing the button triggers the tool and produces a clean, circular fracture (Ø 25 mm) in the shell of embryonated chicken eggs.

Note:

In the moment when the circular punching blade meets the egg's shell, some particles of lime are released.

Convenient

The cap of the egg may be lifted off easily with a sharp knife.

The lower air sac membrane is exposed, intact and readily accessible.

With brief practice, you will be able to quickly and efficiently open 60 or more chicken eggs per minute.



Easy

It should not be totally immersed in liquids.

The EggPunch comes with approx. 1.8 metres of tubing to connect to a compressed air source.

The air pressure may range from 3 to 6 bar (50 to 100 psi).

The circular punching blade is subject to wear and has to be replaced by the user.

The safety nut securing the blade is a disposable suited for one-time use only.

Technical Data

| | |
|----------------------|----------------------------|
| Blade diameter | 25 mm |
| Outer diameter | 28 mm |
| Compressed air range | 3 to 6 bar (50 to 100 psi) |
| Weight | approx. 1 kg |

Ordering Information

| | |
|---|-------------------------------------|
| EggPunch Pneumatic egg-opener | Cat.-No. 3.684 002 |
|---|-------------------------------------|

Spare parts

| | |
|--|------------------|
| Punching blade including disposable safety nut | 3.984 020 |
|--|------------------|

schuett **biotec**.de

Rudolf-Wissell-Straße 13, D-37079 Göttingen, Germany
Fon +49 (0) 551/5 04 10-0, Fax +49 (0) 551/5 04 10-99
info@schuett-biotec.de
www.schuett-biotec.de

Helpful gadgets

For your Laboratory



Weighing dishes made of aluminium



- **weighing dishes, ideal for use in infrared dryers**
- **multifunctional**

Ideal for moisture determination with infrared dryers.
The samples should be distributed

horizontally and reflect the heat evenly over the complete dish area.

May also be used as laboratory dishes.

MAGNETO-STABIL Stirring inserts for beakers



- **Smooth running, no spattering or evaporation of liquid when operating at high speed or continuously**
- **Minimal wear of the stirring bar, the beaker and the sample due to the device's high performance**
- **The conical lid safely prevents from spattering and reduces evaporation**

Stirring inserts available in 3 different sizes suitable for all types of beakers from 100 ml up to 2000 ml capacity.

Designed with a chemical-resistant conical plastic cover with bushing and 2 pipetting bores as well as a PTFE-coated magnetic stirring bar with mounting.

MESSFIX Tubing gauge



- **small and handy**
- **easy measurement**

For easy measurement of the outer or inner diameter of hoses, glass tubes etc. in the range of 1.5 to 16 mm diameter.

A small and handy gauge made of polypropylene, that can easily be carried in every pocket. It is

always ready at hand to check the diameter of a hose or tube.

To determine the inner diameter, the hose is simply shoved to a fitting spike and the diameter can be read.

To measure the outer diameter, the hose is stuck into a fitting hole and the diameter, too, can be read.

TESTIPLATT Test tube tray



- **ideal for serial assays**
- **resistant to acids and alkaline solutions**

Made of hard PVC-foil, vacuum-formed. Ideal for serial assays (e. g. blood tests), resistant to acids and alkaline solutions. Transparent.

72 (6x12) slightly conical tubes

with round bottom, 10 mm diameter, 25 mm deep, 2 ml tube volume.

TESTIPLATT is very suitable as a support for reaction vessels.

Supporting trays made of transparent PVC add stability to TESTIPLATT.

Ordering Information

MAGNETO-STABIL 1
MAGNETO-STABIL 2
MAGNETO-STABIL 3

MESSFIX

TESTIPLATT

TESTIPLATT Supporting tray

Weighing dishes

for beakers 60 - 95 mm Ø, 200 mm height
for beakers 86 - 118 mm Ø, 200 mm height
for beakers 110 - 143 mm Ø, 200 mm height

120 x 12 x 50 mm (w x h x d)

275 x 25 x 137 mm (w x h x d)

100 mm Ø, 7 mm height (qty=80)

Cat.-No.

3.440 102

3.440 202

3.440 302

3.660 103

3.683 073

3.683 073

3.628 103

schuett **biotec** .de

Rudolf-Wissell-Straße 13, D-37079 Göttingen, Germany

Fon +49 (0) 551/5 04 10-0, Fax +49 (0) 551/5 04 10-99

info@schuett-biotec.de

www.schuett-biotec.de

Homogenisation

With Perfection

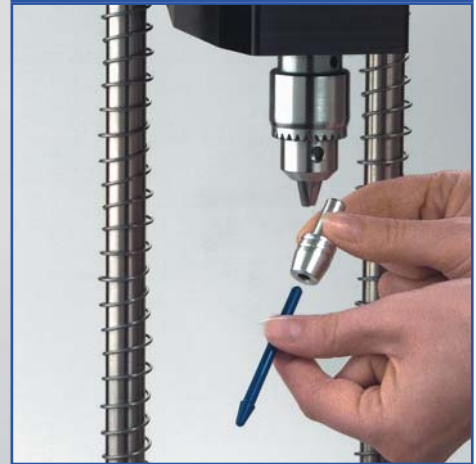

Definition

Homogenisation is the thorough mixing of two components of one system that are immiscible by their nature.

Common application in microbiology is resuspending of cell pellets and disruption of cell clots and cell tissue.

Applications

- 1. Homogenisation of two indissoluble liquids, e.g. creating emulsions**
- 2. Mixing of solids into liquids, e.g. creating suspensions**
- 3. Separating bacteria or yeast cells from the culture medium by centrifugation or resuspending, e.g. washing with buffers**
- 4. Splitting bacteria or yeast cell clots, e.g. for chemical cell disruption**
- 5. Splitting united cell structures, sensitive material, e.g. cell culture, liver etc.**
- 6. Splitting united cell structures, tough material, e.g. muscle, bowel, skin, plant tissue**

Complete disruption into individual cells through homogenisation can only be guaranteed for sensitive material (cell culture, liver tissue, plant tissue etc.). Frequently, homogenisation serves as a preparation step for chemical (detergents), enzymatic or mechanical cell disruption.

Please contact us for mechanical cell disruption systems (French Press System, BioNeb System, Ultrasonic systems etc.).

Homogenisation highly increases the effect of cell disruption and reduces the residence time of chemicals or enzymes.

What do you need for homogenisation?

schuett homger^{plus}

Powered drive-unit at high-torque, in which you may clamp the pestle.

The homogenising vessel is tightly clamped into the cooling vessel on the lifting table.

During homogenisation, the table may easily be lifted up and down with a lever. This assures powerful homogenisation for the up and down movement without any effort from the user.

Pestle

We offer a wide range of pestles made of PTFE, glass-fibre reinforced PTFE, glass, polypropylene or stainless steel in cylindrical or tapered shape.

Homogenising vessel

We offer glass vessels where the inner diameter has highest fitting accuracy. Vessels are available for capacities of 2-40 ml.

Semi-automatic homogeniser



schuett homger^{plus} **Semi-automatic homogeniser**

- **for tough tissue that is difficult to homogenize**
- **high-torque drive-unit, up to 3,000 rpm**
- **vibration-free with robust 3-support-construction**
- **convenient cooling of the samples with ice**
- **including quick-grip clamp for EPPENDORF[®] test tubes**

schuett homger^{plus} consists of a speed-stabilized drive-unit and a cooling vessel with an universal quick-grip chuck. Suitable for all common homogenisers of different sizes.

Its strong performance in a high-speed zone guarantees perfect homogenisation, even when using very small homogenisers (EPPENDORF[®] -scale).

The high-torque drive-unit of the schuett homger^{plus} makes it very suitable for use at low speeds. schuett homger^{plus} combines excellent physical stability with comfortable handling and smooth running properties.

Versatile

Adjustment in height and the locking of the drive-unit are continuously variable, so that an adjustment to homogenising vessels/pestles of various manufacturers is easily possible.

The fast-action clamping chuck with hollow shaft permits rapid and easy replacement of the pestle and permits use of pestles with longer shafts.

schuett homger^{plus} is also suitable for hand-held homogenisers or EPPENDORF[®] reaction vessels.

Furthermore, the use as a high-performance agitator is possible.

Semi-automatic homogeniser

Comfortable and safe

The lever arm moves the table up and down together with the cooling vessel and the tightly clamped homogenising vessel.

The lifting mechanism assures safe and comfortable work, both with tough and sensitive homogenising tasks.

The cooling vessel offers additional working safety in the case of glass-breakage or when using pathogen materials.



Speed-stabilized

schuett homger^{plus} is speed-stabilized with an electronic rotational speed-control variable from 40 to 3,000 rpm. The speed is infinitely variable and remains constant, independent of load changes when homogenising. The standard integrated 4-digit LED-display makes reproducible homogenising possible.

Cooling Vessel

The transparent cooling vessel allows permanent monitoring of the homogenisation and guarantees high working safety.

schuett homger^{plus} is suitable for homogenising sensitive botanical material, animal tissue, anorganic material etc.

Handy cooling of the samples with ice, which can easily be filled into the cooling vessel after opening the screw cap. This prevents sensitive samples from heating during homogenisation.

Universal

The universal clamping adapter of the cooling vessel allows for use of almost all homogenising vessels currently available on the market. Included in delivery are 6 inserts for vessels with various diameters.

Even EPPENDORF® reaction vessels can be used.

Homogenising vessels and inserts are fixed to the chuck and locked.

The unit can also be supplied modified for use in a sterile workbench when operating with infectious substances (optional).

Accessories

schuett homger^{plus} includes a universal quick-grip chuck to use pestles of different shaft diameters and lengths.

To change even quicker and safer, especially when using glass pestles with shaft diameters of 6, 8 or 10 mm, we recommend the use of a quick-grip clamp for glass pestles.

We offer a whole range of homogenising vessels and tapered respectively cylindrical pestles made of glass or PTFE.

Please ask for our special pestles made of stainless steel or polypropylen to use with EPPENDORF®-test tubes or Falcon-tubes.

Homogenisers

Homogenisers

suitable for use with our schuett homger^{plus} semi-automatic homogeniser or any other drive-unit with drill chuck.

The homogenising vessels and pestles of schuett-biotec GmbH are available in different models and sizes as well as with different specific features, i.e. the user may choose a homogenising vessel and pestle that perfectly meets his individual demands - depending on consistency and fibre length of the material to be treated.

All homogenising vessels and pestles are manufactured with utmost precision and care to guarantee highest fitting accuracy to reach a good homogenisation result.

In case of breakage, only the damaged part has to be replaced, the counterpiece may still be used.

Please note for using glass pestles with powered drive-units

When using pestles and homogenising vessels made of glass, both items have to be handled with care as two cut glass surfaces encounter.

The rotational speed should be as slow as possible. Furthermore, the vertical power should only be used to the least possible extent.

When moving, only glass surfaces being covered by liquid should be in contact. Contact between two dry glass surfaces cause resonance vibrations, which may lead to breakage of the glass parts.

Please moisten pestle and homogenising vessel before homogenising. Carefully insert the pestle into the homogenising vessel at a low rotational speed.



Homogeniser with overflow flare with lip and PTFE pestle, tapered



Homogeniser as centrifuge tube with PTFE pestle, cylindrical



Homogeniser with overflow flare with lip and PTFE pestle, cylindrical



Homogeniser with overflow flare with lip and glass pestle, tapered



Homogeniser with overflow flare, without lip and glass pestle, cylindrical



Homogeniser with overflow flare with lip and glass pestle, cylindrical



EPPI-pestle made of polypropylen and stainless steel with quick-grip clamp

Tapered or cylindrical

Depending on the task, one can choose between homogenisers with PTFE pestles or ground glass pestles of tapered or cylindrical shape.

The tapered homogeniser combines two zones for homogenisation. In the tapered zone the material will be pre-homogenised while the final fine-homogenisation takes place in the cylindrical zone.

If the start material already has a fine texture, a cylindrical homogeniser may suffice.

Homogeniser and pestle are of a precise shape and therefore separately exchangeable.

Tapered homogenising vessels

are most suitable for tough tissue that is difficult to homogenise (application 4 and 6).

The distance between pestle and homogenising vessel depends on the immersion depth of the pestle in the tapered part of the vessel. In the tapered part, the material is chopped by moving the pestle up and down before it is homogenised in the cylindrical part of the vessel.

Tapered homogenising vessels reach very good results - even for materials that could virtually not be homogenised in cylindrical vessels.

Cylindrical homogenising vessels

are most suitable for soft tissue as stated in applications 1 to 5.

The straight, cylindrical pestles have a high fitting accuracy to the inner diameter of the homogenising vessel. The tip of the pestle fits exactly the bottom of the homogenising vessel, which forces the homogenising material upwards. The up and down movement of the vessel - and therefore with the shearing action at the walls - causes the homogenisation process.

For application 3, we offer a special homogenising vessel, which may be placed directly into the centrifuge.

This vessel is suitable for centrifuge rotation of up to 4,000 rpm. Cylindrical homogenising vessels produce a very fine homogenisation.



Pestles made of PTFE

With shaft made of stainless steel. Inert, elastic, with a smooth, wax-like moisture-rejecting surface.

Resistant to high temperatures.

Pestles made of PTFE are preferentially used for homogenisation of soft materials (application 1 to 4, possibly 5).

The PTFE pestle tips accurately fit the inner dimensions of the homogenising vessel. All pestles and homogenising vessels of the same size may be exchanged and autoclaved.

PTFE is chemically inert and has a soft wax-like and moisture-rejecting surface. The advantages of PTFE are low heat development, no contamination of the homogenate by glass abrasion, high stability, and trouble-free sterilisation.

In the case where PTFE (flexibiliser) might disturb the analytic, please use glass pestles.

Glass-fibre reinforced PTFE pestles

For especially tough tissue. These pestles are practically unbreakable and cause considerably less contamination of the homogenate due to glass abrasion than glass pestles.

The flexibility of PTFE limits the effectiveness of using PTFE pestles with tough tissue (application 4, possibly 6).

The reinforced PTFE pestles contain 25% of glass and are therefore 10 times tougher; however, they are resistant to chemicals and have a smooth surface.

They are most suitable for material that is rather difficult to homogenise, but still provide the advantages of pure PTFE pestles.

Pestles made of glass

With robust glass shaft. Ground-glass surface in cylindrical/tapered shape. Highly efficient with tough tissue.

Cut glass pestles and homogenising vessels are most suitable for tough material that may cause difficulties during homogenisation (application 6).

Naturally, application 1-5 may be done with glass pestles as well, it is however more comfortable to use PTFE pestles due to the easy handling.

Pestle and homogenising vessel may be exchanged, so that in case of weariness or breakage only the affected part has to be replaced. A motor drive-unit and a quick-grip clamp for glass pestles are recommended to minimize lateral pressure on the glass shaft and to reach sufficient torque with few rotations per minute.

In the case where glass abrasion (quartz particles) may disturb the analytic, please use PTFE pestles.

EPPENDORF®-scale 1.5 ml

EPPI-pestle made of polypropylene (pestle and shaft)

Autoclavable. Facilitates sterile working with serial samples.

We offer special tapered pestles made of autoclavable polypropylene with a capacity of 500 µl for use in EPPENDORF®-test tubes.

The test tubes are safely held in the cooling vessel. Cooling the sample with ice allows for gentle treatment of the samples, e.g. for DNA/RNA-extraction.

Our quick-grip clamp guarantees the treatment of many samples in best time and allows for changing the pestle with running engine.

EPPI-pestle made of stainless steel, cut from solid material.

Autoclavable. They are made from one piece and easy to clean sterilize in order to avoid contamination with germs etc. Suitable for use with liquid nitrogen.

They may be exposed to high and low temperatures (autoclaving, liquid nitrogen).

Our pestles made of stainless steel are most suitable for homogenising small volumes (up to 500 µl) in tapered EPPENDORF®-test tubes being frozen in liquid nitrogen.

The advantages of the quick-grip clamp and the cooling vessel (see above) are adaptable to pestles made of stainless steel as well.

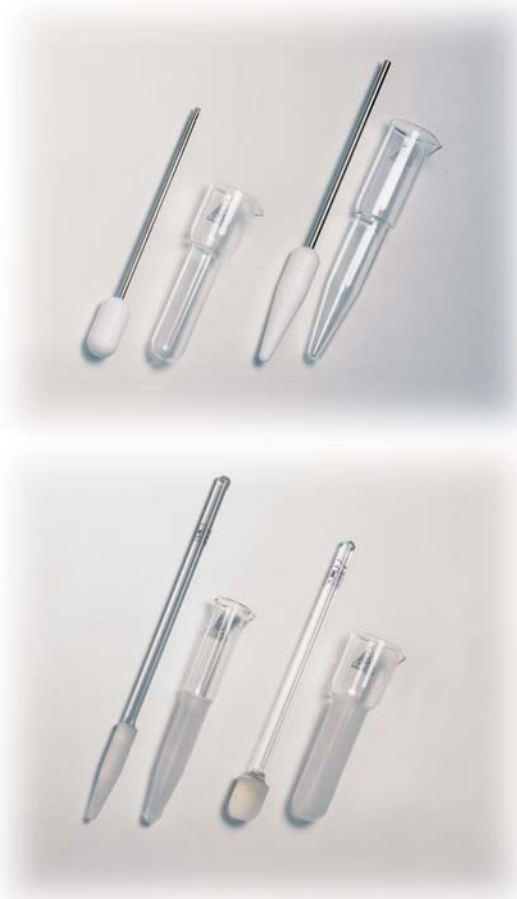

Technical Data

| | |
|------------------------|---|
| Dimensions (w x h x d) | 300 x 888 x 350 mm |
| Speed | 40-3,000 rpm |
| Weight | approx. 15 kg |
| Power | 230 V, 50/60 Hz, 300 W or 115 V, 50/60 Hz, 300 W |

Ordering Information

| | |
|--------------------------------------|-------------------------------------|
| schuett homger^{plus} | Cat.-No. 3.201 011 |
|--------------------------------------|-------------------------------------|

including cooling vessel, universal quick-grip chuck and universal clamping adapter

Accessories

| | |
|------------------------------------|------------------|
| Quick-grip clamp for glass pestles | 3.201 111 |
|------------------------------------|------------------|

Volume**Glass vessel/Pestle****Homogeniser with PTFE pestle, tapered**

| | | |
|-------|-------------------------------|------------------|
| 2 ml | with overflow flare, with lip | 3.211 022 |
| 15 ml | with overflow flare, with lip | 3.211 152 |
| 40 ml | with overflow flare, with lip | 3.211 402 |

Homogeniser with PTFE pestle, cylindrical

| | | |
|--------|-------------------------------|------------------|
| 2 ml | cylindrical | 3.213 022 |
| 5 ml * | cylindrical | 3.213 052 |
| 10 ml | cylindrical | 3.213 102 |
| 15 ml | with overflow flare, with lip | 3.213 152 |
| 20 ml | cylindrical | 3.213 202 |
| 30 ml | cylindrical | 3.213 302 |
| 40 ml | with overflow flare, with lip | 3.213 402 |

Homogeniser with PTFE pestle, cylindrical**glass-fibre reinforced, highly efficient with tough tissue**

| | | |
|--------|-------------------------------|------------------|
| 5 ml * | cylindrical | 3.214 052 |
| 10 ml | cylindrical | 3.214 102 |
| 15 ml | with overflow flare, with lip | 3.214 152 |
| 30 ml | cylindrical | 3.214 302 |
| 40 ml | with overflow flare, with lip | 3.214 402 |

Homogeniser with glass pestle, tapered

| | | |
|-------|-------------------------------|------------------|
| 2 ml | with overflow flare, with lip | 3.216 022 |
| 15 ml | with overflow flare, with lip | 3.216 152 |
| 40 ml | with overflow flare, with lip | 3.216 402 |

Homogeniser with glass pestle, cylindrical

| | | |
|-------|----------------------------------|------------------|
| 8 ml | with overflow flare, without lip | 3.218 082 |
| 15 ml | with overflow flare, without lip | 3.218 152 |
| 40 ml | with overflow flare, with lip | 3.218 402 |

EPPI-pestle**for homogenising with 1.5 ml EPPENDORF®-test tubes**

Made of polypropylen (qty=10)

| | |
|---|------------------|
| shaft-Ø 4.9 mm, total length 70 mm, tapered | 3.200 512 |
|---|------------------|

Made of stainless steel

| | |
|--|------------------|
| shaft-Ø 4.9 mm, total length 100 mm, tapered | 3.200 712 |
|--|------------------|

| | |
|------------------|------------------|
| Quick-grip clamp | 3.200 612 |
|------------------|------------------|

* to be used as centrifuge glass

Volume is the maximum capacity moving inside the tube. The volume of pestle is considered.

schuett **biotec** .de

Rudolf-Wissell-Straße 13, D-37079 Göttingen, Germany
Fon +49 (0) 551/5 04 10-0, Fax +49 (0) 551/5 04 10-99
info@schuett-biotec.de
www.schuett-biotec.de

INCUDRIVE *Rollersystems*

and Incubators



The INCUDRIVE Biotec-motion-systems and the INCUDRIVE incubators are designed for rotating and rolling test tubes and bottles used in cell biology, virology, microbiology and pharmacy.

- ¹ ***INCUDRIVE 90 (optional with CO₂ provision)***
Roller bottle incubator, max. of 90 bottles, for the production of e.g. vaccines using adherent cell cultures
- ² ***INCUDRIVE S***
Incubator with drive unit to rotate and roll up to 630 test tubes or 7 roller bottles.
- ³ ***INCUDRIVE D-I***
Drive unit with incubating hood and air-circulation system to rotate up to 16 roller bottles.
- ⁴ ***INCUDRIVE R***
Roller system with drive unit and roller frame to rotate and roll up to 630 test tubes or 7 bottles for cell culture.
- ⁵ ***INCUDRIVE H***
Incubating hood with air-circulation-system.

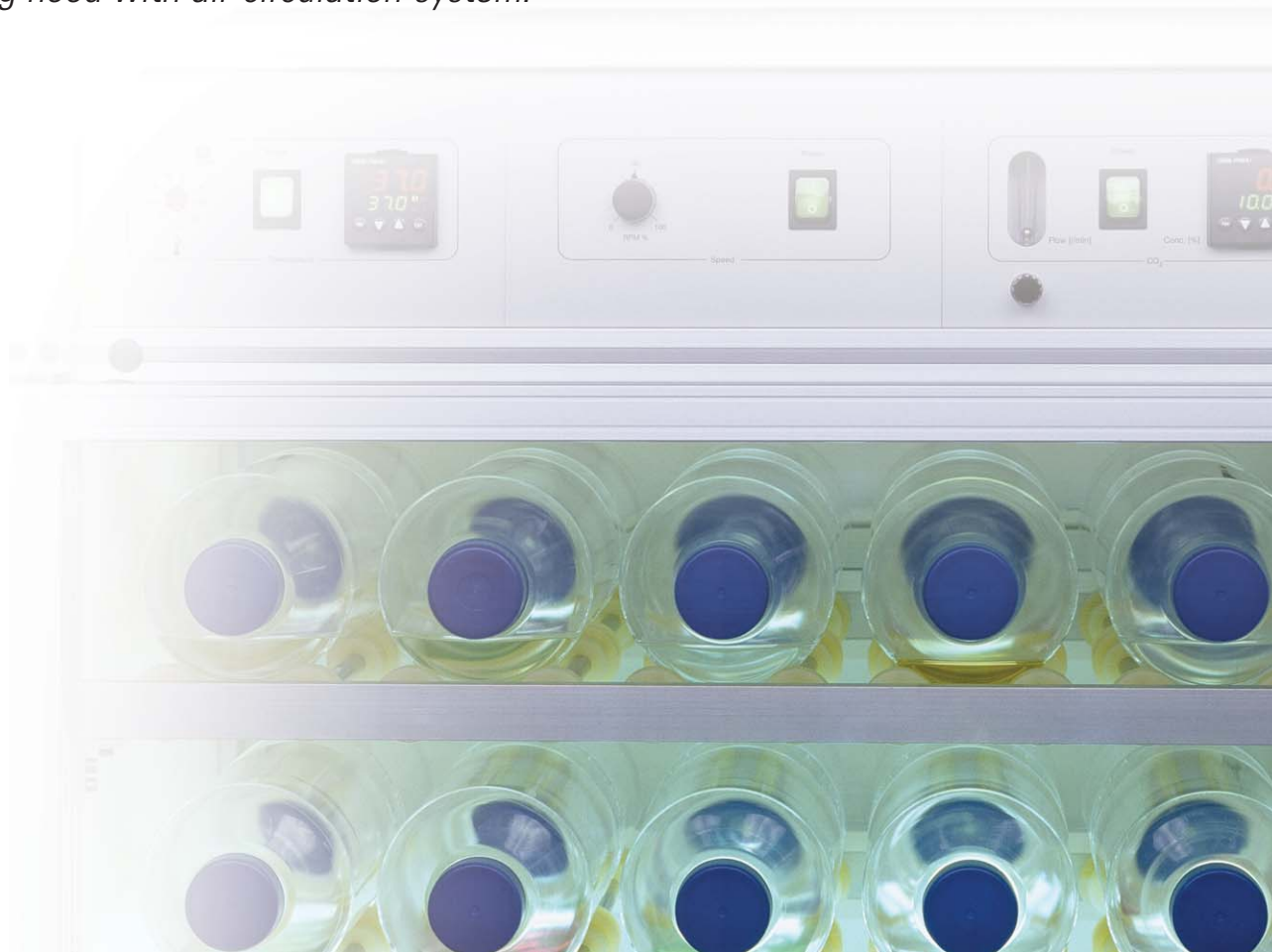

INCUDRIVE 90

●¹ INCUDRIVE 90



Roller bottle incubator, max. of 90 bottles, for the production of e.g. vaccines using adherent cell cultures

- self-contained incubator/roller for 90 bottles
- energy savings
- mobile, built on castors
- passes any standard laboratory door
- limits cross-contamination
- CO₂-provision (optional)
- warm-up period max. 2 hours

Compact

Consists of an incubator and a drive mechanism for rolling up to 90 cell culture bottles with a diameter of between 100 and 120 mm on 9 levels of 5 bottles side by side in 2 rows.

The rotational speed of a bottle with Ø 120 mm is continuously adjustable from 0.1 to 2 rpm.

Heavy-duty, all-metal construction. Roller axles fitted with ball bearings made of stainless steel. Sealed incubation compartment, physically separated from drive mechanism.

A half-transparent front door permits permanent monitoring of incubation compartment.

Energy savings & Flexible

Energy savings

Heating of only the exactly needed space for the cultivation of seed cultures and production cultures results in considerable energy savings compared to heating large warm rooms.

Temperature range is + 5° C above room temperature to + 50° C, temperature continuously adjustable and stabilized, forced air-circulation.

An overheat protection guards against accidental overheating.

Flexible

INCUDRIVE 90 comes with castors and is therefore mobile.

Suitable for roller bottles made by different manufacturers. Can be adjusted to fit varying 2-liter bottle lengths.

Production capacity can be adapted by adding more INCUDRIVE 90 devices as needed. Methods, which are generated inside one INCUDRIVE 90 can be scaled up to the number of devices, which are required for the production.

Production and harvesting can be handled in the same clean-room.

The INCUDRIVE 90 roller bottle incubator allows for working with a second virus without need for an additional warmroom. The same applies if a second temperature is needed.

Documentation relative to Installation Qualification (IQ) and Operation Qualification (OQ) optionally available.

Optionally available for Long Expanded Surface Bottles.

Reliable & Time efficient handling

Reliable

Temperature stability over the entire culture medium is ± 0.7 °C (INCUDRIVE 90 filled with 90 roller bottles). There is an interface available for temperature monitoring (quality management).

Improved safety during production - the risk of problems during cultivation is limited to just the one incubator in question. No cross-contamination.

INCUDRIVE 90 has successfully been validated for the production of veterinary vaccines. Suitable for disinfection by Peracetic Acid 0.2 % concentration.

Time efficient handling

The Bottle Lifter (optional) allows for all 90 bottles to be loaded or removed simultaneously within seconds. The Bottle Lifter is mobile and sterilizable.

It also serves to remove the bottles from the incubator and to transport them to a separate room for harvesting, thereby further minimizing the risk of cross-contamination.

No ramp to be overcome when moving bottles into or out of the incubation compartment.

Of course, the Bottle Lifter may also be transferred to a cooling room for cell disruption by freezing.



Bottle Lifter for loading or removing all bottles simultaneously from the INCUDRIVE 90 (optional)

INCUDRIVE S

●² INCUDRIVE S



Incubator with drive unit to rotate and roll up to 630 test tubes or 7 bottles for cell culture.

The system consists of a high quality incubator fitted with motor drive unit, a roller frame and roller drums (1 to 3 ea. applicable) for the accommodation of test tubes. For loading with tubes or bottles, the roller drums may easily be lifted off the roller frame and taken out of the incubator.

The roller frame can also be taken out of the incubator for cleaning. The roller drums may be tilted for rotating open test tubes.

The robust inner housing is made of corrosion-resistant stainless steel with smooth surfaces and without joints. The edges are rounded and therefore easy to clean. The all-glass door can be taken off its hinges, features a continuously welded notch and a robust lock. Thus, it offers ideal protection against contamination. All controls are located on the front-panel.

The electronic temperature control features easy handling, LED-display of both the actual- and set-temperature and PD/PID-control mode for rapid heating, minimum overshoot and high accuracy.

INCUDRIVE D-I

●³ INCUDRIVE D-I



Drive unit for cell culture bottles and vessels with an outer diameter of 40 - 400 mm.

With incubating hood and air-circulation system:

- slow rotation of cell culture bottles and vessels
- fast rotation for thorough mixing
- maximum length of the vessels 520 mm incl. screw-cap
- with stainless steel ball-bearings, suitable for continuous mode with heavy load
- sterilizable with Peracetic Acid 0.2 %

The device has been designed for use at benchtop. The INCUDRIVE D-I Biotec-motion-system is suitable for defined, slow rotation of horizontally placed culture bottles and vessel. The rotational speed of a cell culture bottle with 120 mm diameter is approx. 0.1 to 4 rpm, continuously adjustable.

The device provides space for up to 4 individually removable roller inserts. The vertical placement of the roller inserts is predetermined. Alternatively, there may be wire mesh trays with mounting brackets instead of roller inserts to allow for placing various equipments in the same environmental/temperature conditions.

The toothed belt transmission from motor to drive axles reliably prevents from slippage or stopping of the bottles. The door of the incubator is made of transparent, thermally insulated UV-resistant plastics for permanent monitoring of the experiment without opening the door.

The temperature is regulated by an air-circulation system with integrated electronic temperature control. Additionally, the actual and set temperature is constantly shown on the LED-display.

The temperature is adjusted with an electronic control by using a keypad.

Additional safety provides an overheating guard that may be automatically reset.

INCUDRIVE R

●⁴ INCUDRIVE R



Roller system with drive unit and roller frame, to rotate and roll up to 630 test tubes or 7 bottles for cell culture. May be combined with INCUDRIVE H.

- slow rotational speed for the cultivation of microorganisms and cell cultures in test tubes
- fast rotational speed for optimal supply with oxygen
- inclination of the frame can be adjusted
- easily removable drum to handle samples
- for up to 420 tubes 160 x 16 mm respectively 630 tubes 100 x 16 mm

To slowly rotate drums with test tubes and bottles. Perfectly suitable for tubes that are not hermetically sealed.

The device was designed for use in an incubating room or other temperature-controlled environment.

The rotational speed of the drums is continuously variable from 0.06 to 2.0 rpm. The inclination of the frame may be adjusted individually.

Custom-made roller drums for other vessels may be manufactured on request.

INCUDRIVE H

●⁵ INCUDRIVE H



Incubating hood with air-circulation system. Open bottom. May be combined with INCUDRIVE R.

The hood was designed for use with various kinds of experiments or apparatus on even surfaces, e.g. vortexers or other devices.

The door and sidewalls of the incubating hood are made of transparent thermally insulated windows that allow for permanent monitoring of the samples without opening the door.

The incubating hood features soft rubber lining at the bottom for passage of power cords. The air-circulation as well as the heating unit and all controls are located at the top of the device. The integrated air-circulation system provides for homogenous temperature distribution.

The LED-display shows simultaneously the actual and set temperature.

The settings for temperature can be adjusted directly on the electronic controller. Additionally, a mechanical overheating protection for the device is included.

Technical Data

●¹ **INCUDRIVE 90**
Roller bottle incubator



●² **INCUDRIVE S**
Roller bottle incubator



| | | |
|---|---|--|
| Rotational speed (bottle Ø 110 mm) | 0.1-2 rpm | 0.1-2 rpm (other rotational speed on request) |
| Rotational speed of drum | - | 0.1-2 rpm (other rotational speed on request) |
| Vessel diameter | 40-120 mm | 16 mm (tube) 120 mm (bottle) Special design available |
| Roller rack (tilt angle) | - | 0-10° |
| Drum diameter | - | 380 mm |
| Temperature range | | |
| Temperature stability inside the medium | +/- 0.7 °C | < +/- 1 °C |
| Working temperature internal | + 30 - + 50 °C room temperature + 20 °C * | + 30 - + 70 °C room temperature + 20 °C |
| Environmental temperature | + 5 °C up to + 40 °C | + 5 °C up to + 40 °C |
| Temperature control | electronic with actual and set temperature display | electronic with actual and set temperature display |
| Temperature stability | function of time +/- 0.2 °C function of location +/- 1 °C | function of time +/- 0.5 °C function of location +/- 0.9 °C |
| Heating | forced air-circulation fixed air speed | - |
| Temperature sensor | Pt 100 | Pt 100 |
| Overheat protection, adjustable | 0 up to + 70 °C | yes (without °C-graduation) |
| Power & Dimensions | | |
| Power | 230 V, 50-60 Hz, 1,300 W max. or 115 V, 50-60 Hz, 1,300 W max. | 230 V, 50-60 Hz, 550 W or 115 V, 50-60 Hz, 550 W |
| Dimensions outer (w x h x d) | 800 x 1,950 x 950 mm | 895 x 840 x 715 mm |
| Dimensions inner (w x h x d) | 675 x 1,540 x 655 mm | 554 x 644 x 550 mm |
| Dimensions (w x h x d, without drum) | - | - |
| Dimensions (w x h x d, with drum) | - | - |
| Weight | approx. 260 kg | approx. 110 kg |

* Low temperatures with cooling on request.

●³ **INCUDRIVE D-I**
Drive unit



●⁴ **INCUDRIVE R**
Roller system



●⁵ **INCUDRIVE H**
Incubating hood



| | | |
|---|---|---|
| 0.1-4 rpm | - | - |
| - | 0.1-2.0 rpm (optional 0.75-15 rpm) | - |
| 40-500 mm | 16 mm (tube) 120 mm (bottle) Special design available | - |
| - | 0-10° | - |
| - | 380 mm | - |
| < +/- 1 °C | - | - |
| + 30 - + 50 °C | - | + 30 - + 50 °C |
| room temperature + 20 °C | - | room temperature + 20 °C |
| + 5 °C up to + 40 °C | - | + 5 °C up to + 40 °C |
| electronic | - | electronic |
| with actual and set temperature display | - | with actual and set temperature display |
| function of time +/- 0.2 °C | - | function of time +/- 0.2 °C |
| function of location +/- 1°C | - | function of location +/- 1°C |
| forced air-circulation | - | forced air-circulation |
| fixed air speed | - | fixed air speed |
| Pt 100 | - | Pt 100 |
| 0 up to + 70 °C | - | 0 up to + 70 °C |
| 230 V, 50-60 Hz, 330 W or 115 V, 50-60 Hz, 330 W | 230 V, 50-60 Hz, 80 W or 115 V, 50-60 Hz, 80 W | 230 V, 50-60 Hz, 280 W or 115 V, 50-60 Hz, 280 W |
| 610 x 920 x 780 mm | - | 650 x 750 x 560 mm |
| 560 x 740 x 550 mm | - | 600 x 585 x 455 mm |
| - | 450 x 150 x 400 mm | - |
| - | 450 x 500 x 400 mm | - |
| approx. 45 kg | approx. 7 kg (without drum) | approx. 10.5 kg |



| Ordering Information | | Cat.-No. |
|--|--|------------------|
| ● ¹ | INCUDRIVE 90 <i>Roller Bottle Incubator for 90 roller bottles</i> | 3.068 001 |
| | INCUDRIVE 90 CO₂ <i>Roller Bottle Incubator for 90 roller bottles with CO₂-provision</i> | 3.069 001 |
| Accessories | | |
| | Bottle Lifter <i>for loading and removing all 90 bottles simultaneously from the INCUDRIVE 90</i> | 3.068 011 |
| ● ² | INCUDRIVE S <i>Incubator with drive unit (without roller frame and drums)</i> | 3.051 001 |
| | Accessories | |
| | Roller frame <i>for Drums</i> | 3.055 101 |
| | Drum R <i>for 7 roller bottle with Ø 120/125 mm, max. 1 per device</i> | 3.056 071 |
| | Drum K10 <i>for 210 culture tubes 100 x 16 mm, max. 3 per device</i> | 3.056 101 |
| | Drum K16 <i>for 210 culture tubes 160 x 16 mm, max. 2 per device</i> | 3.056 161 |
| | Drum M <i>for other vessels (custom-made), max. 2 per device</i> | 3.056 311 |
| ● ³ | INCUDRIVE D-I <i>Roller Bottle Incubator for optional equipment with roller insert or roller drums</i> | 3.060 001 |
| | INCUDRIVE D-I CO₂ <i>Roller Bottle Incubator for optional equipment with roller insert or roller drums, with CO₂-provision</i> | 3.066 001 |
| Accessories for equipment with roller inserts (max. 4 per device) | | |
| | Roller insert <i>with 2 mounting brackets and 8 stainless steel ball bearing axles, for 4 bottles with Ø 70-120 mm or 3 bottles with Ø 40-70 mm, max. 4 roller inserts per device or 2 bottles with Ø 120-240 mm, max. 2 roller inserts per device or 1 bottle with up to Ø 400 mm, max. 1 roller insert per device (Weight of rolling goods up to max. 10 kg per level and max. 25 kg per device Maximum length of the vessels is 500 mm)</i> | 3.061 011 |
| Accessories for equipment with roller drums | | |
| | Drum insert <i>for roller frame</i> | 3.063 011 |
| | Roller frame <i>for Drums</i> | 3.055 101 |
| | Drum R <i>for 7 roller bottle with Ø 120/125 mm, max. 1 per device</i> | 3.056 071 |
| | Drum K10 <i>for 210 culture tubes 100 x 16 mm, max. 3 per device</i> | 3.056 101 |
| | Drum K16 <i>for 210 culture tubes 160 x 16 mm, max. 2 per device</i> | 3.056 161 |
| | Drum M <i>for other vessels (custom-made), max. 2 per device</i> | 3.056 311 |
| ● ⁴ | INCUDRIVE R <i>Roller System with drive unit and mounted roller rack (without drums)</i> | 3.064 001 |
| | Accessories | |
| | Drum R <i>for 7 roller bottles with Ø 120/125 mm, max. 1 per device</i> | 3.056 071 |
| | Drum K10 <i>for 210 culture tubes 100 x 16 mm, max. 3 per device</i> | 3.056 101 |
| | Drum K16 <i>for 210 culture tubes 160 x 16 mm, max. 2 per device</i> | 3.056 161 |
| | Drum M <i>for other vessels (custom-made), max. 2 per device</i> | 3.056 311 |
| ● ⁵ | INCUDRIVE H <i>Incubating hood with a large front door for small devices or to be combined with INCUDRIVE R</i> | 3.065 001 |

schuett  **biotec.de**

Rudolf-Wissell-Straße 13, D-37079 Göttingen, Germany
Fon +49 (0) 551/5 04 10-0, Fax +49 (0) 551/5 04 10-99
info@schuett-biotec.de
www.schuett-biotec.de

schuett solaris

It's magic ... Sterilize with light

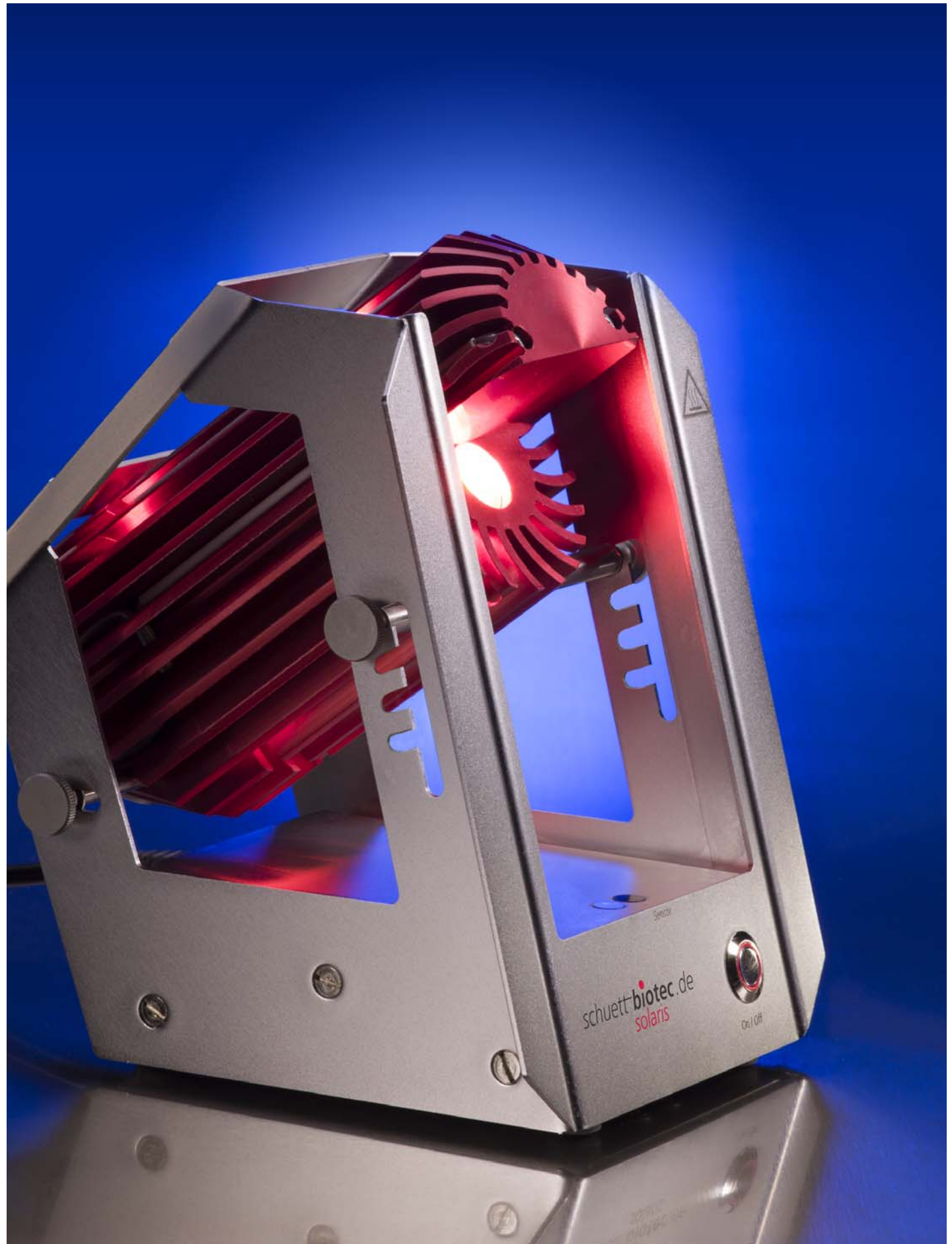

schuett **biotec**.de



schuett solaris Loop Sterilizer
Sterilization of inoculating loops, tweezers and small instruments
within seconds

- **Electrical, no gas needed, no open flame**
- **Instant-ready-to-use, no warm-up time, no waiting**
- **Sterilization temperature 900 – 1,300 °C, 1,650 – 2,370 °F**
- **Touch-free START, with IR- sensor and integrated timer**
- **Economical, low-cost operation**

schuett solaris is the perfect alternative to the Safety Bunsen Burner or to the conventional Bunsen burner. The preferred solution where an open flame is to be avoided, gas cartridges are not readily available or the provision of a central gas supply is too expensive.

Used with standard electrical power, the device reaches the safe working temperature of 900 – 1.300 °C within the split of a second. No warm-up time necessary, no preheating.

START is generated by an infra-red sensor, which allows for one-handed operation. The metal portion of the loop-holder with the inoculating loop is exposed to the **schuett solaris Loop Sterilizer** for a preset 5 seconds. Sterilization of both the loop and the shaft of the loop holder will result simultaneously.

The integrated timer can be set to either 5 or 7 seconds. Once set, the timer guarantees a fixed and reproducible working cycle. An easily accessible quartz tube serves as the sterilization chamber. It keeps pathogenic material from spreading and can easily be removed for cleaning.

User-friendly: the **schuett solaris** offers four fixed angular working positions, with intermediate stops at the user's discretion.

The **schuett solaris** is robust and sturdy. There are no parts subject to mechanical wear. Low heat development during operation. The level of heat development depends upon the set sterilization time and the overall time of a work session. Even if in continuous use, this unit poses no hazard to the user if touched by hand.

Heat is generated only during the actual sterilization process. No energy consumption between work cycles.

Long-term studies have shown that the low heat generation of the device enhances the well-being of the user as it does not have a drying effect on the user's face or eyes.

When used in Laminar Flow Cabinets a significant benefit of the **schuett solaris** is its low level of heat emission as it does not interfere in any major way with the laminar air flow. It also does not emit soot which could impair the function of HEPA-Filters.

The **schuett solaris** Loop Sterilizer is well qualified for service both in the laboratory and in the demanding environment of field-use.

As its operation does not require oxygen, the **schuett solaris** can be used in anaerobic conditions.

.... even if there is no gas – Electrical power is always available !

Technical Data

schuett solaris

| | |
|------------------------|--|
| Dimensions (w x h x d) | 152 x 210 x 195 mm |
| Weight | approx. 2.500 g |
| Temperature | 900 °C ... 1.300 °C |
| Connected voltage | 100-120 VAC bzw. 200-240 VAC, 50-60 Hz, 500 W Short-time |
| Safety class | IP 20 |

Ordering information

| | |
|--|-------------------------------------|
| <i>schuett solaris</i> , 230 V | Cat.-No. 3.399 002 |
| <i>schuett solaris</i> , 115 V | 3.399 012 |
| Quartz tube with bottom (qty.=2), outer-Ø 17 mm, length 100 mm | 3.399 502 |

Optional Accessories

| | |
|--|-----------|
| Inoculating loops Stainless steel 0,5 mm thickness, 60 mm long (qty=10) Cat.-No. (Loop-Ø) 3.686 312 (1,5 mm)/ 3.686 322 (2,5 mm)/ 3.686 332 (4 mm) | |
| Inoculating loops Special stainless steel 0,5 mm thickness, 60 mm long (qty=10) Cat.-No. (Loop-Ø) 3.686 112 (1 mm)/ 3.686 122 (2 mm)/ 3.686 132 (3 mm)/ 3.686 152 (5 mm) | |
| Inoculating loops Platin-Iridium-wire (90/10), 0,5 mm thickness, 60 mm long (qty=1) Cat.-No. (Loop-Ø) 3.686 212 (1 mm)/ 3.686 222 (2 mm)/ 3.686 232 (3 mm)/ 3.686 252 (5 mm) | |
| Inoculating loop holders Inoculating loop holders,160 mm | 3.686 362 |
| Inoculating loop holders,240 mm | 3.686 442 |
| Racks for inoculating loop holders with 6 holes a Ø 7 mm | |
| Rack R (round), 80 x 50 mm (Ø x h) | 3.687 082 |
| Rack L (long) | |
| 180 x 50 x 50 mm (w x h x d) | 3.687 182 |

Yeast Genetics

TDM Tetrad Dissection Microscope Ci-L



Complete System

TDM Tetrad Dissection Microscope Ci-L

- **ergonomic system accelerates tests in yeast genetics**
- **Micromanipulator mounted on the mechanical stage**
- **simultaneous operation of fine focus and micromanipulator**

Ergonomically optimized, simplifies and accelerates tests in yeast genetics.

The **TDM Ci-L** is a complete system for comfortable and efficient tetrad dissection. This third generation design incorporates Nikon®'s newest and most ergonomic laboratory microscope, the **ECLIPSE Ci-L** with infinity optic.

The **TDM Ci-L** offers a precision joystick micromanipulator, a holder for Ø 100 mm Petri dishes, and a mechanical stage with "click-stops". The microscope is complete with long working distance optics for viewing through the reversed dish and growing medium.

Micromanipulator

The Precision Micromanipulator is mounted on the left side of the stage and both move simultaneously, when the microscope is focused, thus there is no need for a fixed stage. Other than the previous designs, the sideways movements are led by ball bearing slides, whereas the joystick allows for a smooth and hysteresis-free adjustment of Y- and Z-axis. The X-axis is adjusted by turning a knob.

The Mechanical Stage has low coaxial control knobs, which are tension adjustable. The stage is indexed with "click-stops" every 5 mm on the X- and Y-axis. Petri dishes with Ø 100 mm of various manufacturers can be used, because of the unique design of the dish holder.

Nikon®'s new patented one-side fine focus allows for the operation of the stage and the fine focus with one hand.

Microscope

The Nikon® Microscope ECLIPSE Ci-L is comfortably designed with a 22° binocular body. Options are available to adjust the height of the eyepieces for even the tallest of operators. Focusing and micromanipulation can be done with both arms resting on the bench top.

The **TDM Ci-L** comes with an Abbe condenser, which has been modified so that it provides proper Köhler illumination over the extended distance to the object.

Stand and stage are built for right-hand operation (left-hand operation optional).



Mechanical stage with micromanipulator
*Image similar

Technical Data

| | |
|-----------------------|---|
| Typ | overall magnification max. 200x |
| Oculars | CFI oculars 10x, field of view 22 mm |
| Object lens of survey | CFI Plan Achromat 2x, numeric aperture 0.06, working distance 7.5 mm |
| Object lens for work | CFI Achromat LWD 20x, numeric aperture 0.40, working distance 3.9 mm (at a thickness of the cover glass of 0.17 mm) |
| Weight | approx. 14 kg |
| Power | 100-240 V, 50-60 Hz (AC adapter, all-purpose) |

Ordering Information

| | |
|---------------------------------------|-------------------------------------|
| TDM Tetrad Dissection Microscope Ci-L | Cat.-No. 3.090 200 |
| Micro needle (qty=10) | 3.090 300 |
| Micro needle holder | 3.090 400 |

schuett **biotec**.de

Rudolf-Wissell-Straße 13, D-37079 Göttingen, Germany
Fon +49 (0) 551/5 04 10-0, Fax +49 (0) 551/5 04 10-99
info@schuett-biotec.de
www.schuett-biotec.de

schuett **petriturn**



Turntables for Petri dishes & Inoculating hooks



schuett petriturm-E with foot-switch and turntable-attachment for Petri dishes up to Ø 150 mm (optional)



Inoculating hook made of stainless steel (Drigalski-hook)



Inoculating hook made of glass (Drigalski-hook)

Easy & Uniform

Petri dishes turntables

For uniform plating of liquids on agar-surfaces in Petri dishes. Easy to handle, tireless.

schuett petriturm-E Electrically driven Petri dish turntable

With electrically drive and sensor. Body made of stainless-steel. Handling of the turntable contactless by sensor. For Petri dishes up to Ø 100 mm (up to Ø 150 mm optional).

Continuously adjustable, constant speed of 10-100 rpm and continuously adjustable operating time of 3 s to 2 min or permanent running.

Optional connection of a foot-switch.

Turntables for Petri dishes of other diameters available on request.

Comfortable

schuett petriturm-M Manual operation

Powerful and long-running due to high mass of turntable.

Useable on both sides, that means two work spaces in one device by easiest turn-over. For Petri dishes with Ø 100 and Ø 150 mm diameter.



schuett petriturm-M

Technical data

petriturm-E

| | |
|---|---------------------------------|
| Dimensions (Ø x h) | 160 x 70 mm |
| Weight | approx. 1 kg |
| Wall power supply | 12 V DC 5 VA |
| Speed continuously, adjustable | up to 10-120 rpm |
| Operating time, continuously adjustable | 3 s - 2 min / permanent running |

petriturm-M

| | |
|--------------------|----------------|
| Dimensions (Ø x h) | 160 x 45 mm |
| Weight | approx. 2.3 kg |

Ordering Information

| | Cat.-No. |
|---|-----------|
| schuett petriturm-E, electrically driven, 230 V | 3.361 252 |
| schuett petriturm-E, electrically driven, 115 V | 3.361 262 |
| schuett petriturm-M, manual operation | 3.361 102 |

Accessories

| | |
|--|-----------|
| Foot-switch for schuett petriturm-E | 3.361 302 |
| Turntable-attachment for Petri dishes up to Ø 150 mm | 3.361 402 |

Inoculating hook

| | |
|--|-----------|
| Inoculating hook made of stainless steel (Drigalski-hook), 180 mm length | 3.362 152 |
| Inoculating hook made of glass (Drigalski-hook), 145 mm length | 3.362 162 |

schuett**biotec**.de

Rudolf-Wissell-Straße 13, D-37079 Göttingen, Germany
Fon +49 (0) 551/5 04 10-0, Fax +49 (0) 551/5 04 10-99
info@schuett-biotec.de
www.schuett-biotec.de

EcoVac *safety-vacuum-system*

Removal of liquid excess



EcoVac

EcoVac
safety-vacuum-system for the
removal of liquid excess

- **autoclavable safety-bottle**
- **low-noise and low-vibration**
double-chambered
membrane pump
- **excellent cost-efficiency**

The EcoVac safety-vacuum-system supports efficient work and increases the safety standard when working with infectious material in a laboratory.

EcoVac easily removes pathogenic liquid excess from dishes, bottles, tubes, disks etc. and transfers to a safety vacuum bottle made of break-resistant and autoclavable polypropylene.

User-friendly concept

EcoVac is a highly functional solution and extremely cost-efficient at the same time.

We recommend a standard pasteur-pipette to remove the excess. It can easily be used with silicone tubing, which connects to the safety vacuum bottle.

Further silicone tubing connects the safety vacuum bottle to the vacuum-system, i.e. the vacuum pump or central vacuum.

Safety & Comfort

More safety and comfort

The safety vacuum bottle is resistant to chemicals, has a large capacity and therefore decreases time-consuming autoclaving and disposing to a minimum.

The screw-cap of the bottle comes with two self-locking fittings, which seal the bottle and lock the vacuum bottle hermetically, when the tubing is removed for transport and autoclaving.



The aeration insert ensures the needed pressure equalization when autoclaving.

Space saving

EcoVac only needs a minimum of space in your laboratory. Only the pasteur pipette with the silicone tubing and the vacuum bottle take up work space. By cutting the silicone tubing as needed, the system can easily be adapted to your individual working conditions.

Accessories

Vacuum pump

The vacuum pump is a double-chambered membrane pump with an illuminated on/off-switch.

Foot-switch

Allows to operate the pump if the EcoVac system should be used intermittently.

Safety filter

The safety filter between the vacuum bottle and the pump prevents the pump from contamination or consequences of aggressive gases or liquids.

Technical Data

Safety vacuum bottle

| | |
|-------------------------------|---------------|
| Capacity | 2 or 4 litres |
| Material | polypropylene |
| Working temperature (min/max) | 0 °C/121 °C |

Safety filter

| | |
|------------------|---------------|
| Diameter | 62 mm |
| Housing material | polypropylene |
| Filter material | PTFE |
| Pore size | 0.2 µm |

EcoVac vacuum pump

Double-chambered membrane pump
low-noise and low-vibration
with on/off-switch

| | |
|------------------------|------------------|
| Dimensions (w x h x d) | 80 x 60 x 160 mm |
| Weight | approx. 850 g |
| Max. performance | 4 l/min. |
| Final vacuum | 300 mbar |
| Power | 230 V, 50-60 Hz |



Ordering Information**Cat.-No.****EcoVac safety-vacuum-system 2****3.350 022**

incl. safety PP-bottle (2 litre)
with screw cap, 2 self-locking fittings,
aeration insert, safety filter and
silicone tubing 2x 1.5 m (autoclavable)

EcoVac safety-vacuum-system 4**3.350 042**

incl. safety PP-bottle (4 litre)
with screw cap, 2 self-locking fittings,
aeration insert, safety filter and
silicone tubing 2x 1.5 m (autoclavable)

Accessories**EcoVac vacuum pump****3.350 102**

with connection cable, 1 m

Foot-switch

3.350 202

Safety filter (qty=2)

3.350 302

Glass-pasteur-pipettes, 150 mm (qty=1000)

3.350 402

Glass-pasteur-pipettes, 230 mm (qty=1000)

3.350 502**Replacements**

EcoVac replacement safety PP-bottle, 2 litre

3.350 122

EcoVac replacement safety PP-bottle, 4 litre

3.350 142

schuett **biotec**.de

Rudolf-Wissell-Straße 13, D-37079 Göttingen, Germany

Fon +49 (0) 551/5 04 10-0, Fax +49 (0) 551/5 04 10-99

info@schuett-biotec.de

www.schuett-biotec.de

Multi-Pulse-Vortexer

Mixing and Homogenizing

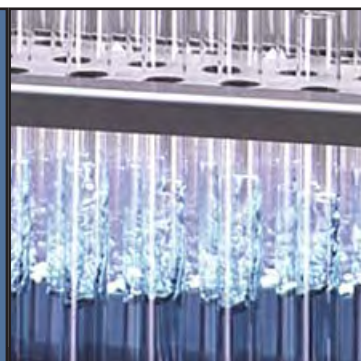

Powerful

Multi-Pulse-Vortexer

- **efficient vortexing of large sample volume**
- **pulsing feature interrupts action for more thorough mixing**
- **easily adapted to different vessels**
- **high effectiveness for enzymatic reactions**
- **reproducible results due to thorough mixing**

Powerful and thorough vortexing large sample volume
The Multi-Pulse-Vortexer is especially suitable for vortexing large sample volume.

The standard version has space for 22 reagent vessels.

Efficient

The powerful drive system (max. 2,500 rpm) ensures thorough mixing of even the toughest samples. The speed range is continuously adjustable.

Additional pulse function

Samples with a tendency to form layers are no problem for the Multi-Pulse-Vortexer. The system's additional pulsing feature interrupts the vortexing process briefly to allow for thorough mixing.

The pulsing frequency is continuously adjustable.

Thorough Homogenisation

Adding glass or steel beads to the sample causes homogenisation of the material. The pulsing feature guarantees a complete homogenisation of the entire sample.

Applications

Variety of sizes to fit most applications

The Multi-Pulse-Vortexer allows working with all common types of sample vessels, simply by changing the cartridge size. The Multi-Pulse-Vortexer adapts easily to different sample volumes - without the need to purchase additional attachment adapters.

Whether microtiter plates, cryo-tubes, reagent vessels, Falcon tubes, Erlenmeyer or other vessels, the adapter is the same - only the insert changes. The insert can be height adjusted.

Using the optional blank inserts, allows for using the unit for most standard tube racks or with complete test tube racks.

Technical Data

| | |
|------------------------|-------------------------|
| Dimensions (w x h x d) | 450 x 180 x 360 mm |
| Speed | 0-2,500 rpm |
| Weight | approx. 16 kg |
| Power | 230 V, 180 VA, 50-60 Hz |

Ordering Information

Multi-Pulse Vortexer, 230 V,
including two inserts suitable for tubes
Ø 12 - 13 mm and Ø 15 - 16 mm

Cat.-No.

3.200 001

Accessories

Inserts for Multi-Pulse Vortexer

| Vessel Ø | Capacity | |
|-----------------------------|----------|-----------|
| 12 -13 mm | 22 Tubes | 3.200 002 |
| 15 -16 mm | 22 Tubes | 3.200 012 |
| 18 -20 mm | 19 Tubes | 3.200 022 |
| 25 mm | 12 Tubes | 3.200 032 |
| 28 -29 mm | 10 Tubes | 3.200 042 |
| Type of vessel | Capacity | |
| 96er multiwell plates | 2 each | 3.200 052 |
| 125 ml Erlenmeyer flasks | 2 each | 3.200 062 |
| 250 ml Erlenmeyer flasks | 2 each | 3.200 072 |
| 1.5/2.0 ml reaction vessels | 84 tubes | 3.200 082 |
| 12 mm cryo-tubes | 36 tubes | 3.200 092 |

Blank cartridge

for working with other vessels/racks

3.200 102

schuett **biotec**.de

Rudolf-Wissell-Straße 13, D-37079 Göttingen, Germany
Fon +49 (0) 551/5 04 10-0, Fax +49 (0) 551/5 04 10-99
info@schuett-biotec.de
www.schuett-biotec.de

RULLA 2

Wet-Penetration-Test



schuett **biotec**.de
RULLA 2

RULLA 2 Wet Penetration Test

RULLA 2 Wet-Penetration-Test

- Electrically driven, timer controlled turntable
- Holds agar plates of \varnothing 140 mm
- Rotational speed of the turntable $60 \text{ rpm} \pm 1 \text{ rpm}$
- Sliding weight to adjust the pressing force exerted by the stainless steel finger onto the material over the entire range from 1 N to 3 N
- Excentric speed is 5.60 rpm
- The pressing force (e.g. 3 N \pm 0.02 N) exerted by the stainless steel finger onto the material can be measured/set with a spring balance (included with shipment), which may be hooked to the dynamometer attachment point located on top of the finger

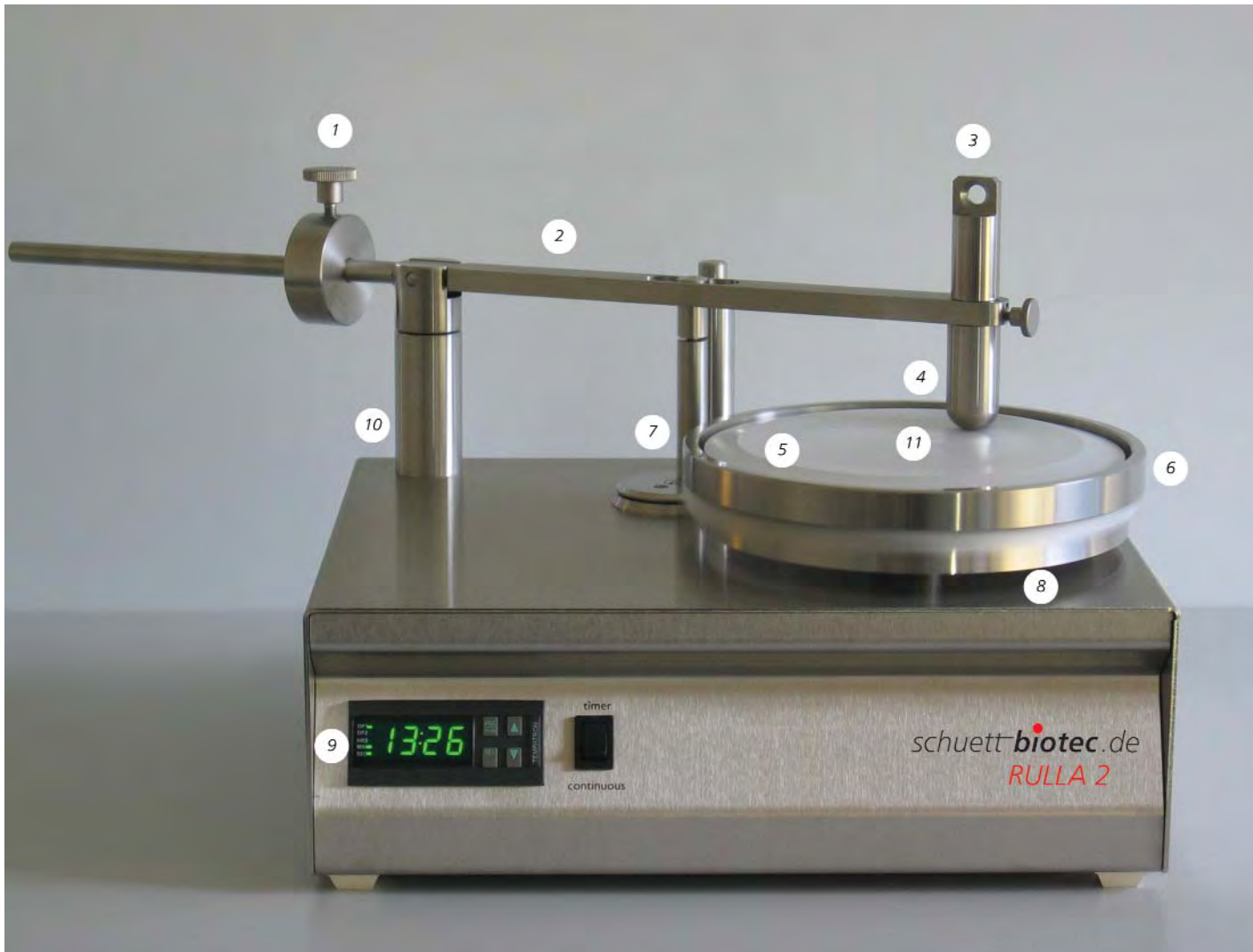

RULLA II Wet-Penetration-Test with tenter frame (optional)

Description: (1) Counterweight, (2) Balancing arm with finger, (3) Dynamometer attachment point, (4) Stainless steel finger, (5) Petri dish (optional), (6) Tenter frame (two-part stainless steel ring, optional), (7) Excentric, (8) Turntable, (9) Timer, (10) Ball bearing, (11) Cover-/carrier-/reference material (optional)

Test according to EN ISO 22610

INFECTION CONTROL AND HEALTHCARE Wet Bacterial Penetration Test

- test according to EN ISO 22610
- toothed wheel transmission, free of slippage; load compensated drive system
- programmable digital timer
- housing, finger and turntable made of stainless steel
- optional accessories:
 - Tenter frame
 - Cover-/carrier-/
 - Reference material
 - Petri dishes with Ø 140 mm

Apparatus for measuring the resistance to wet bacterial penetration of surgical drapes and surgical gowns

Test according to EN ISO 22610

Principle of operation is based on and in accordance with CEN/TC205 WG 14 as per EN ISO 22610. Surgical drapes, gowns and clean air suits, used as medical products, for patients, clinical staff and equipment - Test method to determine the resistance to wet bacterial penetration.

Originally the Swedish standard HSS 8760019 was used as a basis for these measurements.

Free of Slippage & Load Compensated

Toothed wheel transmission, free of slippage, load compensated drive system

The RULLA 2 wet penetration test is supplied with a fixed ratio toothed wheel transmission which works free of slippage and guarantees to reliably cover the complete test area with the practically wearfree stainless steel finger during the preset time of 15 minutes. The load compensated drive system ensures a constant rotational speed of the agar plate holder of 60 ± 1 rpm over the entire force pressure range of 1 N to 3 N effected by the stainless steel finger.

Programmable timer

The timer is preset by the manufacturer to 15 minutes, i.e. the proper period needed to perform the test according to the above



standard. The digital timer is user-programmable to set other test periods in the range of 1 second to 99 minutes and 59 seconds with an accuracy of ± 1 sec.

The large LED display shows either the preset test period or while in operation shows the remaining run-time.

Housing, finger and turntable made of stainless steel

All essential parts of the housing are made of stainless steel, i.e. can easily be cleaned. The finger and the agar plate holder are made of stainless steel and can easily be removed for cleaning and disinfecting.



Housing & Accessories

Optional accessories

The major accessories to perform the test are optionally available. The support-cylinder is used during preparation for the test to stabilize the cover-/carrier-/reference material and assists in getting a smooth working surface of the materials inside the tenter frame. Additives to the agar and the strain of *S. aureus* are not offered.

A dynamometer attachment point is located in-line with the center of the finger for a spring balance to calibrate the pressing force of the stainless steel finger onto the test material.

Technical Data

| | |
|------------------------|---|
| Dimensions (w x h x d) | 520 x 220 x 280 mm |
| Weight | approx. 10.5 kg |
| Power | 230 V, 50-60 Hz, 60 W or 115 V, 50-60 Hz, 60 W |

Ordering Information**Cat.-No.**

| | |
|--|------------------|
| RULLA 2 Wet-Penetration-Test, 230 V incl. built-in digital timer and precision spring balance | 3.091 100 |
| RULLA 2 Wet-Penetration-Test, 115 V incl. built-in digital timer and precision spring balance | 3.092 100 |

Accessories

| | |
|---|------------------|
| RULLA 2 Tenter frame 800 g +/- 1 g, stainless steel (inner + outer ring) | 3.091 110 |
| RULLA 2 Support cylinder, autoclavable, Ø 90 mm, 40 mm height | 3.091 120 |
| RULLA 2 Wet-Penetration-Test Set consisting of: 1x HDPE safety sheet and 1x PU/PE carrier sheet (qty=100) | 3.091 130 |
| RULLA 2 Reference material according to EN ISO 22610: 135 g/m ² micro-filament polyester fabric washed three times according to ISO 15707 (qty=10) | 3.091 140 |
| RULLA 2 Petri dishes Ø 140 mm, 20 mm height (qty=176) | 3.091 200 |

Spare parts

| | |
|---|------------------|
| RULLA 2 Precision spring balance According to EN ISO 22610, see also EN 13795 and EN 14126 | 3.991 110 |
|---|------------------|

schuett **biotec**.de

Rudolf-Wissell-Straße 13, D-37079 Göttingen, Germany
Fon +49 (0) 551/5 04 10-0, Fax +49 (0) 551/5 04 10-99
info@schuett-biotec.de
www.schuett-biotec.de

*schuett***biotec**.de

*schuett-biotec GmbH
Rudolf-Wissell-Straße 13
D-37079 Göttingen
Germany*

*Fon +49 (0) 551/5 04 10-0
Fax +49 (0) 551/5 04 10-99*

*info@schuett-biotec.de
www.schuett-biotec.de*

